

# Sporting and Technical Regulations



**PORSCHE**

**MICHELIN  
SPRINT CHALLENGE  
AUSTRALIA**

TITLE PARTNER



## 2023 Porsche Michelin Sprint Challenge Australia Series Sporting and Technical Regulations



Version 1

Published 25/02/2023



**Motorsport Australia** ABN: 55 069 045 665  
275 Canterbury Rd, Canterbury VIC 3126  
Phone: +61 3 9593 7777 Hotline: 1300 883 959  
[motorsport.org.au](http://motorsport.org.au)

# 2023 Porsche Michelin Sprint Challenge Australia Series

## Sporting & Technical Regulations

A capitalised and italicised word in this document is defined in the FIA International Sporting Code (*Code*), the National Competition Rules (*NCR*), including their Appendices or Attachment I of this document.

Any HEADING is for reference only and has no regulatory effect.

### Contents

<b>S1</b>	<b>TITLE AND JURISDICTION .....</b>	<b>6</b>
	<b>S1.1</b> Title .....	6
	<b>S1.2</b> Authority / Jurisdiction.....	6
<b>S2</b>	<b>ADMINISTRATION.....</b>	<b>6</b>
	<b>S2.1</b> Personnel .....	6
<b>S3</b>	<b>COMPETITOR ELIGIBILITY .....</b>	<b>7</b>
<b>S4</b>	<b>AUTOMOBILE ELIGIBILITY .....</b>	<b>7</b>
	<b>S4.1</b> General.....	7
	<b>S4.2</b> List of Eligible Automobiles .....	7
	<b>S4.3</b> Replacement <i>Automobile</i> .....	7
<b>S5</b>	<b>DRIVER ELIGIBILITY .....</b>	<b>7</b>
	<b>S5.1</b> <i>Driver</i> Classification.....	7
	<b>S5.2</b> Substitute <i>Driver</i> .....	7
	<b>S5.3</b> Seeded <i>Driver</i> .....	7
<b>S6</b>	<b>SERIES ROUNDS / REGISTRATION.....</b>	<b>8</b>
<b>S7</b>	<b>SERIES CALENDAR .....</b>	<b>8</b>
<b>S8</b>	<b>ROUND FORMAT .....</b>	<b>8</b>
<b>S9</b>	<b>GRID DETERMINATION .....</b>	<b>8</b>
<b>S10</b>	<b>START PROCEDURE .....</b>	<b>9</b>
<b>S11</b>	<b>AWARDS AND POINTSCORE .....</b>	<b>9</b>
	<b>S11.1</b> Prizes and Trophies .....	9
	<b>S11.2</b> <i>Series</i> Pointscore .....	9
	<b>S11.3</b> Jim Richards Endurance Trophy .....	10
<b>S12</b>	<b>EVENT OPERATIONS.....</b>	<b>11</b>
	<b>S12.1</b> <i>Series</i> Registration and <i>Entry</i> .....	11
	<b>S12.2</b> <i>Driver</i> /Team Manager Briefings.....	11
	<b>S12.3</b> <i>Parc Fermé</i> .....	11
	<b>S12.4</b> Practice.....	12
	<b>S12.5</b> Qualifying.....	12
	<b>S12.6</b> Warm Up.....	12
	<b>S12.7</b> <i>Pit Lane</i> .....	12
	<b>S12.8</b> Removal of <i>Automobile</i> from the paddock .....	12
	<b>S12.9</b> Radio Communication to/from <i>Automobile</i> .....	12

<b>S12.10</b>	Race Management Channel ( <i>RMC</i> ) .....	13
<b>S12.11</b>	Lap Triggers .....	13
<b>S12.12</b>	Leaving the <i>Circuit</i> whilst under investigation .....	13
<b>S13</b>	<b>TYRES</b> .....	<b>13</b>
<b>S13.1</b>	Tyre Regulations.....	13
<b>S13.2</b>	Table New tyre usage.....	15
<b>S13.3</b>	Table Previously nominated tyre usage .....	15
<b>S14</b>	<b>FUEL</b> .....	<b>15</b>
<b>S15</b>	<b>AUTOMOBILE MARKINGS</b> .....	<b>15</b>
<b>S15.1</b>	Exclusivity.....	15
<b>S15.2</b>	<i>Automobile</i> Markings and <i>Series</i> Identification.....	16
<b>S15.3</b>	Competition Number .....	16
<b>S16</b>	<b>DRIVER APPAREL</b> .....	<b>16</b>
<b>S16.1</b>	Standard of Apparel .....	16
<b>S16.2</b>	Reserved Signage on Racing Overalls.....	17
<b>S17</b>	<b>TESTING RESTRICTIONS</b> .....	<b>17</b>
<b>S18</b>	<b>RAIN LIGHT</b> .....	<b>17</b>
<b>S19</b>	<b>IN-CAR CAMERAS</b> .....	<b>17</b>
<b>S19.1</b>	In-Car System .....	17
<b>S19.2</b>	TV Production Cameras.....	17
<b>S20</b>	<b>GROUND CLEARANCE</b> .....	<b>18</b>
<b>S21</b>	<b>ABS</b> .....	<b>18</b>
<b>S22</b>	<b>TELEMETRY, DATA RECORDING SYSTEMS</b> .....	<b>18</b>
<b>S23</b>	<b>DRY TO WET PROCEDURE</b> .....	<b>18</b>
<b>S24</b>	<b>PASSENGER RIDES</b> .....	<b>19</b>
<b>S25</b>	<b>PORSCHE AUSTRALIA CODE OF CONDUCT</b> .....	<b>19</b>
<b>ATTACHMENT A</b> .....		<b>21</b>
AUTOMOBILE MARKINGS .....		21
<b>ATTACHMENT B</b> .....		<b>22</b>
FUEL CONTAINER.....		22
<b>ATTACHMENT C</b> .....		<b>23</b>
IN-CAR CAMERA RESERVED SIGNAGE.....		23
<b>GENERAL TECHNICAL REGULATIONS</b> .....		<b>24</b>
<b>T1</b>	<b>PREAMBLE</b> .....	<b>24</b>
<b>T2</b>	<b>PRINCIPLES OF THE TECHNICAL REGULATIONS</b> .....	<b>24</b>
<b>T3</b>	<b>ELIGIBILITY</b> .....	<b>24</b>
<b>T3.1</b>	Eligible <i>Automobiles</i> .....	24
<b>T3.2</b>	Original Components .....	25
<b>T3.3</b>	Examination for Eligibility.....	25
<b>T4</b>	<b>SCRUTINEERING</b> .....	<b>25</b>
<b>T4.1</b>	Onus on <i>Competitor</i> .....	25
<b>T4.2</b>	Scrutineering and Technical Checks .....	25
<b>T4.3</b>	Subsequent Scrutineering .....	26

T4.4	Targeted Scrutineering.....	26
<b>T5</b>	<b>COCKPIT.....</b>	<b>26</b>
T5.1	Safety Cage.....	26
T5.2	Windscreens.....	26
T5.3	Pit Lane Speed Limiter.....	26
T5.4	Seat.....	27
T5.5	Safety Harnesses.....	27
T5.6	Window Nets.....	27
T5.7	Cool Suit Associated Components.....	27
T5.8	Drink Bottle.....	27
T5.9	In-Car Cameras.....	27
T5.10	Timing Transmitters.....	27
T5.11	Fire Extinguisher.....	27
T5.12	Coachwork.....	28
T5.13	Ventilation.....	28
<b>T6</b>	<b>TRANSMISSION.....</b>	<b>28</b>
<b>T7</b>	<b>ENGINE TYPE.....</b>	<b>28</b>
<b>T8</b>	<b>ENGINE AND TRANSMISSION REPAIRS.....</b>	<b>28</b>
<b>T9</b>	<b>SEALS.....</b>	<b>29</b>
<b>T10</b>	<b>SUSPENSION.....</b>	<b>29</b>
T10.1	Suspension.....	29
T10.2	Damper/Springs.....	30
T10.3	Ground Clearance.....	30
T10.4	Anti-Roll bars.....	30
<b>T11</b>	<b>TELEMETRY, DATA RECORDING SYSTEMS AND ECU.....</b>	<b>30</b>
T11.1	Telemetry.....	30
T11.2	Data Recording Systems.....	30
T11.3	ECU and Wiring Loom.....	30
T11.4	Verification – ECU Data Monitor.....	31
<b>T12</b>	<b>WHEELS.....</b>	<b>31</b>
<b>T13</b>	<b>RACING WEIGHT.....</b>	<b>31</b>
<b>T14</b>	<b>LUBRICANTS.....</b>	<b>32</b>
T14.1	Engine Oil.....	32
T14.2	Gearbox Oil.....	32
<b>T15</b>	<b>FUEL SYSTEM.....</b>	<b>32</b>
<b>T16</b>	<b>REAR SPOILER.....</b>	<b>32</b>
<b>T17</b>	<b>FRONT LIP.....</b>	<b>32</b>
<b>T18</b>	<b>EXHAUST SYSTEM.....</b>	<b>32</b>
<b>T19</b>	<b>COOLING SYSTEM.....</b>	<b>32</b>
<b>T20</b>	<b>BRAKES.....</b>	<b>33</b>
<b>T21</b>	<b>STEERING.....</b>	<b>33</b>
<b>ATTACHMENT D.....</b>		<b>34</b>
RECOGNITION DOCUMENT.....		34

**ATTACHMENT E ..... 37**  
    LOCATION OF TIMING TRANSMITTER (FLOOR PAN REMOVED) ..... 37

**ATTACHMENT F ..... 38**  
    DIFFERENTIAL LOCK RAMP ANGLES..... 38

**ATTACHMENT G..... 39**  
    EXHAUST SYSTEMS ..... 39

**ATTACHMENT H..... 40**  
    REQUEST FOR REPAIRS ..... 40

**ATTACHMENT I ..... 41**  
    DEFINITIONS ..... 41

# 2023 Porsche Michelin Sprint Challenge Australia Series

## Sporting Regulations

### S1 TITLE AND JURISDICTION

#### S1.1 Title

This *Series* will only be known as and referred to as the “2023 Porsche Michelin Sprint Challenge Australia Series”.

#### S1.2 Authority / Jurisdiction

- 1.2.1 Each *Round* in the 2023 Porsche Michelin Sprint Challenge Australia Series (*Series*) will be held in accordance with the FIA International Sporting Code including Appendices; the National Competition Rules (*NCR*) and Circuit Race Standing Regulations (*CRSR*) of *Motorsport Australia*; the Sporting and Technical Regulations issued for this *Series* by *Motorsport Australia*; *Supplementary Regulations* issued by the *Organiser* for each *Round*; Bulletins issued by the Stewards and any *Driver Briefing Notes* and instructions issued by the *RD* or Clerk of the Course at an *Event*.
- 1.2.2 This Series has been sanctioned by Motorsport Australia as an Authorised Series.
- 1.2.3 Porsche Cars Australia Pty Ltd (PCA) has been appointed as the Category Manager (CM) by Motorsport Australia for this Series.

Contact Details: Porsche Cars Australia Pty Ltd (ABN 67 004 327 048)  
Barry Hay  
109-111 Victoria Parade  
Collingwood VIC 3066  
Tel: (03) 9473 0941  
Fax: (03) 9415 7906

### S2 ADMINISTRATION

#### S2.1 Personnel

- 2.1.1 The following personnel have been appointed to the *Series* by *Motorsport Australia* and/or the CM and have the authority to administer the various aspects of these regulations as detailed in the *CRSR*.
- |         |  |                  |
|---------|--|------------------|
| 2.1.1.1 | Category Administrator ( <i>CA</i> )     | Barry Hay        |
| 2.1.1.2 | Race Director ( <i>RD</i> )              | David Stuart     |
| 2.1.1.3 | Deputy Race Director ( <i>DRD</i> )      | Krystian Jackson |
| 2.1.1.4 | Technical Delegate ( <i>TD</i> )         | Stacey Paynter   |
| 2.1.1.5 | PAG Technical Advisor ( <i>TA</i> )      | Jesse Hammond    |
| 2.1.1.6 | Driving Standards Advisor ( <i>DSA</i> ) | Karl Reindler    |

### S3 COMPETITOR ELIGIBILITY

To be eligible to compete in the *Series*, each *Competitor* must hold a current Motorsport Australia Competitor Licence and be a party to a current Participation Agreement with the *CM*.

### S4 AUTOMOBILE ELIGIBILITY

#### S4.1 General

- 4.1.1 Each *Automobile* must comply with the requirements of the 2023 Porsche Michelin Sprint Challenge Australia Series Technical Regulations and be detailed in the List of Eligible Automobiles to be eligible to compete in the *Series*.
- 4.1.2 Each Class A *Automobile* must be registered with the *CM* and must be the subject of a current Race Vehicle Authorisation Certificate (RVAC) issued by *PCA*.

#### S4.2 List of Eligible Automobiles

<b>Class A</b>	Porsche GT3 Cup Type911 Gen II (MY 17-20)
<b>Class B</b>	Porsche GT3 Cup Type 911 Gen 1 (MY 13-16)

#### S4.3 Replacement *Automobile*

Following the commencement of the first practice session of each *Round*, any *Automobile* that has been entered to compete at that *Round* may not be replaced with another *Automobile*.

### S5 DRIVER ELIGIBILITY

To be eligible to compete in the *Series*, a *Driver* must be a minimum of 16 years of age and hold a current Motorsport Australia Circuit Licence with Provisional endorsement or higher.

#### S5.1 Driver Classification

- 5.1.1 Each *Driver* will be assessed by the *CM* prior to entering the *Series* and will be deemed to be one of the following classifications for the purpose of awarding class points:
  - 5.1.1.1 Pro
  - 5.1.1.2 Pro-Am
- 5.1.2 Each *Driver* will be advised in writing by the *CM* of their classification.
- 5.1.3 Unless otherwise advised by the *CM*, a *Driver* who has won a race in any Class of the Carrera Cup Australia Championship/Series will be deemed to be Pro.
- 5.1.4 A *Driver's* classification may be changed at any time as determined and advised by the *CM*.

#### S5.2 Substitute *Driver*

Prior to the commencement of the first qualifying session at each round of the *Series*, a *Competitor* may nominate a substitute *Driver* who may be permitted to compete in the remainder of the *Event* subject to the approval of the Stewards and the *CM*.

#### S5.3 Seeded *Driver*

- 5.3.1 The *Series* is for un-seeded *Drivers*. A person who is considered to be a Seeded *Driver* is not eligible to drive in the *Series*.

5.3.2 A Seeded Driver is anyone whose background, performances and achievements are considered in the absolute discretion of the CM to be that of a Seeded Driver.

## S6 SERIES ROUNDS / REGISTRATION

- 6.1 The Series will be conducted over 6 Rounds as detailed in the Series Calendar below.
- 6.2 Each race conducted as a part of the Series will count in determining the final results.
- 6.3 Each Competitor will be required to be registered with the CM prior to competing in the Series.

## S7 SERIES CALENDAR

The Series will be conducted over the following Rounds:

Round	Date	Circuit
1 <sup>^^</sup>	3 – 5 March	Phillip Island
2 <sup>^^</sup>	28 – 30 April	Queensland Raceway
3 <sup>^^</sup>	19 – 21 May	Symmons Plains
4 <sup>^^</sup>	28 – 30 July	Sydney Motorsport Park
5 <sup>^^</sup>	13 – 15 October	The Bend Motorsport Park
6	9 – 11 November	Mount Panorama

<sup>^^</sup> Denotes a Round which includes races counting towards the Jim Richards Endurance Trophy.

**Note:** The above calendar is subject to change. The CM will advise each Competitor of any change.

## S8 ROUND FORMAT

### S8.1 General

- 8.1.1 The number, length and format of Track sessions will ultimately be negotiated between the CM and the Organiser prior to a Round and will be advised in the *Supplementary Regulations* issued for an Event.
- 8.1.2 Generally, the format for each Round will be as follows:
- 8.1.2.1 Practice - 2 x 30-minute practice sessions (normally Friday).
  - 8.1.2.2 Qualifying - 1 x 20-minute qualifying session (normally Saturday).
  - 8.1.2.3 Races - A minimum of 60 minutes of race time will be scheduled at each Round as detailed in the *Supplementary Regulations*.

### S8.2 Variations to Timetable

The timetable may be varied at any time due to exceptional circumstances only with the prior approval of the Stewards.

## S9 GRID DETERMINATION

The grid for each race at each Round will be determined as detailed in the *CRSR* (Progressive grid).



## S10 START PROCEDURE

Unless otherwise stated in the *Supplementary Regulations*, the *Start* procedure for each race will be a Non-Championship standing Start as detailed in the *CRSR* except that, where approved by *Motorsport Australia*, the formation lap may be greater than 1 lap of the *Track*.

## S11 AWARDS AND POINTSCORE

### S11.1 Prizes and Trophies

11.1.1 Prizes, trophies and awards will be as determined by the *CM* and will be advised to each *Competitor*.

11.1.2 A minimum of 4 *Rounds* must be conducted for a winner of the *Series*, each Class and the Jim Richards Endurance Trophy to be declared.

### S11.2 Series Pointscore

11.2.1 Unless otherwise detailed in the *Supplementary Regulations*, points will be awarded to *Drivers* for each race in the *Series* as follows:

Finishing Position	Points	Finishing Position	Points	Finishing Position	Points
1 <sup>st</sup>	60	10 <sup>th</sup>	20	19 <sup>th</sup>	7
2 <sup>nd</sup>	54	11 <sup>th</sup>	18	20 <sup>th</sup>	6
3 <sup>rd</sup>	48	12 <sup>th</sup>	16	21 <sup>st</sup>	5
4 <sup>th</sup>	42	13 <sup>th</sup>	14	22 <sup>nd</sup>	4
5 <sup>th</sup>	36	14 <sup>th</sup>	12	23 <sup>rd</sup>	3
6 <sup>th</sup>	32	15 <sup>th</sup>	11	24 <sup>th</sup>	2
7 <sup>th</sup>	29	16 <sup>th</sup>	10	25 <sup>th</sup>	1
8 <sup>th</sup>	26	17 <sup>th</sup>	9	26 <sup>th</sup>	1
9 <sup>th</sup>	23	18 <sup>th</sup>	8	27 <sup>th</sup>	1

11.2.2 In addition to the above, 1 point will be awarded to the *Driver* in each Class achieving pole position during Qualifying. This point will be added to the *Round* points.

11.2.3 Points will only be awarded to the *Drivers* classified as finishers in the final results of each race.

11.2.4 Points will be awarded for the following Classes:

11.2.4.1 Class A - Pro

11.2.4.2 Class A – Pro-Am

11.2.4.3 Class B

11.2.5 Each *Driver* in the Pro Class who is classified as a finisher in a race will be awarded Pro Class points in accordance with the Table S11.2 relative to each other *Driver* who is classified as a finisher in the Pro Class in that race.

11.2.6 The *Driver* who accumulates the greatest number of Pro Class points over the total number of *Rounds* that are conducted (subject to Article S11.1.2 and S11.2.11) will be declared the winner of the 2023 Porsche Michelin Sprint Challenge Australia Series.

- 11.2.7 Each *Driver* in the Pro-Am Class who is classified as a finisher in a race will be awarded Pro-Am Class points in accordance with Table S11.2 relative to each other *Driver* who is classified as a finisher in the Pro-Am Class in that race.
- 11.2.8 The *Driver* who accumulates the greatest number of Pro-Am points over the total number of *Rounds* that are conducted in their respective Class (subject to Article S11.1.2 and S11.2.11) will be declared the winner of the 2023 Porsche Michelin Sprint Challenge Australia Series Pro-Am Class.
- 11.2.9 Each *Driver* in Class B who is classified as a finisher in a race will be awarded Class B points in accordance with Table S11.2 relative to each other *Driver* who is classified as a finisher in Class B in that race.
- 11.2.10 The *Driver* who accumulates the greatest number of Class B points over the total number of *Rounds* that are conducted in their respective Class (subject to Article S11.1.2(b) and S11.2.11) will be declared the winner of the 2023 Porsche Michelin Sprint Challenge Australia Series Class B.
- 11.2.11 In addition to Articles S11.2.6, S11.2.8 and S11.2.10, if a *Driver* is unable to attend a *Round* solely due to Government restrictions imposed because of the COVID-19 pandemic, the *CM* will have the discretion to alter the number of *Rounds* that may be used to accumulate points for each *Driver* in that Class to determine the winner of the Class, e.g. if 5 *Rounds* have been conducted, only each *Driver's* 4 highest scoring *Rounds* may be used. Each *Round* where this occurs will be considered separately by the *CM* and any decision will be advised to each *Competitor* by the *CM*. Any decision of the *CM* in this regard will not be subject to protest or appeal.
- 11.2.12 The results for each Class at a *Round* will be determined by the number of points scored by each *Driver* at that *Round*. If there is a tie at the end of any *Round*, the final positions for that *Round* will be determined by comparing the results of each of the tied *Drivers* in the final race of that *Round*. The higher place in the *Round* results will be awarded to the *Driver* with the higher finishing position in the final race.
- 11.2.13 If there is a tie at the end of the *Series* in any Class, final positions will be determined by comparing the race results achieved by each tied *Driver* in the *Rounds* they used to accumulate points for the *Series*, with the *Driver* with the highest number of first places in Class being awarded the higher *Series* position. If at this stage a tie still exists, it will be resolved by comparing the number of second, third or fourth places (and so on) achieved by each tied *Driver* until all positions have been determined.

### **S11.3 Jim Richards Endurance Trophy**

- 11.3.1 The Jim Richards Endurance Trophy will consist of 5 x 40-minute races across 5 *Events* as outlined in [Table S7](#).
- 11.3.2 Points will only be awarded to the *Drivers* classified as finishers in the final results of each Jim Richards Endurance Trophy race.
- 11.3.3 The *Driver* who accumulates the greatest number of points over the total number of Endurance Trophy races that are conducted (subject to Article S11.1.2 and S11.3.4(d)) will be the winner of the Jim Richards Endurance Trophy.
- 11.3.4 In addition to Article S11.3.3, if a *Driver* is unable to attend a *Round* that has an Endurance Trophy race solely due to Government restrictions imposed because of the COVID-19 pandemic, the *CM* will have the discretion to alter the number of races that may be used to accumulate points for each *Driver* to determine the winner of the Jim Richards Endurance Trophy, e.g. if 5 races have been conducted, only each *Driver's* 4 highest scoring races may be used. Each *Round* where this occurs will be considered separately by the *CM* and any decision will be advised to each *Competitor* by the *CM*. Any decision of the *CM* in this regard will not be subject to protest or appeal.

- 11.3.5 If there is a tie at the end of the Jim Richards Endurance Trophy, final positions will be determined by comparing the race results achieved by each tied *Driver* in the races they used to accumulate points for the Trophy, with the *Driver* with the highest number of first places being awarded the higher position. If at this stage a tie still exists, it will be resolved by comparing the highest number of second, third and fourth places (and so on) achieved by each tied *Driver* until all positions have been determined. If after the application of this rule a tie still exists the higher position will be awarded to the *Driver* with the higher finishing position in the final Jim Richards Endurance Trophy race.

## S12 EVENT OPERATIONS

### S12.1 Series Registration and Entry

The *Series* will operate under the Motorsport Australia Series Registration and Entry Process. Series Registration and Entry Forms will be available from the *CM* with document checking being conducted by the *CM* prior to the first official *Track* session at each *Round*.

### S12.2 Driver/Team Manager Briefings

- 12.2.1 Each *Driver* and Team Manager (i.e. an appropriately authorised representative of the *Competitor*, other than the *Driver*) must attend the compulsory Drivers/Team Manager Briefing.
- 12.2.2 The time and location of this briefing will be detailed in the *Supplementary Regulations* for the *Event*.
- 12.2.3 The attendance sheet must be signed by the *Driver* and the Team Manager to confirm attendance.
- 12.2.4 Other compulsory briefings may be convened as required and will be advised to each *Competitor* accordingly.

### S12.3 Parc Fermé

- 12.3.1 The location of *Parc Fermé* for each *Round* will be confirmed in the *Supplementary Regulations* or the *Event Driver* information notes provided by the *CM* prior to the *Event*.
- 12.3.2 Each *Automobile*, including those remaining in *Pit Lane*, must proceed directly to the designated *Parc Fermé* area via the most direct route (or as directed by Officials) at the conclusion of qualifying without interference from any third party (other than an Official).
- 12.3.3 Each *Automobile* completing each race must proceed directly to the designated *Parc Fermé* area via the most direct route (or as directed by Officials) at the conclusion of the race, without returning to pit or paddock areas and without interference from any third party (other than an Official).
- 12.3.4 1 team member per *Automobile* may be permitted to enter the designated *Parc Fermé* area for the purpose of checking tyre pressures only. This will be permitted at the direction of the *TD* or the Chief Scrutineer only and the team member must leave the *Parc Fermé* area immediately once the tyre pressure check is completed.
- 12.3.5 Except at the direction of the *TD* or the Chief Scrutineer, an *Automobile* may not be removed from any *Parc Fermé*.
- 12.3.6 Unless authorised by the *TD*, Teams are prohibited to work on an *Automobile* in the *Pit Lane* once the chequered flag has been displayed at the conclusion of a qualifying session.
- 12.3.7 Any *Automobile* that enters the *Pit Lane* or is still in the fast lane after the chequered flag is displayed must remain in the fast lane and proceed to the *Parc Fermé* or as otherwise directed by an official. Any work, including taking tyre pressures, is prohibited until the *Automobile* is in the *Parc Fermé*.

## **S12.4 Practice**

- 12.4.1 The order in which each *Automobile* proceeds onto the *Track* for the first practice session at *Round 1* will be the order of the previous year's *Series* final outright point score followed by any new *Drivers* to the *Series* in competition number order.
- 12.4.2 The order in which each *Automobile* proceeds onto the *Track* for the first practice session from *Round 2* onwards will be determined by the *Series* point-score order at the conclusion of the previous *Round*.
- 12.4.3 The order in which each *Automobile* proceeds onto the *Track* for the second and subsequent practice sessions at a *Round* will be determined by the lap times achieved from the previous practice session with the *Automobile* which achieved the fastest lap time proceeding on to the *Track* first and so on.
- 12.4.4 If an *Automobile* is unable to proceed onto the *Track* in the order specified above, the *CM* may indicate to the next *Automobile* to take its place in the order.
- 12.4.5 During each practice session each *Automobile* must park nose in at an angle of approximately 45 degrees in their allocated pit bay when in *Pit Lane*.

## **S12.5 Qualifying**

- 12.5.1 The order in which each *Automobile* proceeds onto the *Track* at the commencement of each qualifying session will be determined by the lap times achieved in the combined practice sessions at the *Event* with the *Automobile* which achieved the fastest lap time proceeding onto the *Track* first and so on.
- 12.5.2 If an *Automobile* is unable to proceed onto the *Track* in the order specified above, the *CM* may indicate to the next *Automobile* to take its place in the order.
- 12.5.3 During qualifying an *Automobile* may not return to the paddock/garage area without the express permission of the *TD*. If an *Automobile* exits *Pit Lane* to the paddock/garage during qualifying it will be prohibited to re-join that session.
- 12.5.4 During each qualifying session each *Automobile* must park nose in at an angle of approximately 45 degrees in their allocated pit bay when in *Pit Lane*.

## **S12.6 Warm Up**

During each Warm Up session each *Automobile* must parallel park in their allocated pit bay when in pit lane.

## **S12.7 Pit Lane**

- 12.7.1 Each pit crew member is required to sign a *Pit Lane* Indemnity Form prior to the first *Track* session and to display identification as and if required by the *Organiser*.
- 12.7.2 Pit crew members are prohibited to work on an *Automobile* in the "fast lane" at any time, including whilst the *Automobile* is queued waiting to re-enter the *Track* after a red flag period.

## **S12.8 Removal of *Automobile* from the paddock**

When initial scrutineering of an *Automobile* is complete, it is prohibited to remove that *Automobile* from the paddock (other than to go on *Track*) prior to the release of all *Automobiles* from the *Parc Fermé* established following the final race of that *Round* without the prior written approval of the *TD*.

## **S12.9 Radio Communication to/from *Automobile***

Two-way radio communication between the *Driver* and a member of the pit crew is mandatory at all times whilst the *Automobile* is on the *Track*.

### **S12.10 Race Management Channel (RMC)**

- 12.10.1 A minimum of 1 senior team member for each competing *Automobile* must monitor *RMC* at all times during practice, qualifying or racing.
- 12.10.2 This team member must monitor *RMC* from the time that the marshalling of *Automobiles* commences prior to their release from the pit/paddock bay until all *Automobiles* have returned to their allocated pit/paddock bay at the conclusion of any practice session, qualifying session or race.
- 12.10.3 All relevant messages received on the *RMC* must be relayed to the *Driver*.
- 12.10.4 Details of the *RMC* frequency will be available from the *CM*.

### **S12.11 Lap Triggers**

- 12.11.1 The use of individual beacons is prohibited.
- 12.11.2 The Category beacon will be placed, where possible, as close to the *Control Line* at each *Circuit* for the first *Track* session.

### **S12.12 Leaving the *Circuit* whilst under investigation**

If a *Competitor* or *Driver* leaves the *Circuit* without the permission of the *RD* whilst under investigation, any penalty imposed by the Stewards as a result of that investigation will be binding and not subject to appeal.

## **S13 TYRES**

### **S13.1 Tyre Regulations**

- 13.1.1 Only the control tyres listed below, complete with barcode identification, are permitted for use in the *Series*:

	<b>Dry Weather Tyres</b>	<b>Wet Weather Tyres</b>
Front	Michelin slick tyre – 27/65-18 Porsche Cup N2#	Michelin wet tyre – 27/65-R18 P2L
Rear	Michelin slick tyre – 31/71-18 Porsche Cup N2	Michelin wet tyre – 31/71-R18 P2L

- 13.1.2 Only tyres supplied by the following supplier may be used:

European Technique  
 338 Swan Street  
 Richmond VIC 3121  
 Ph: 03 9428 5547  
 Fax: 03 9428 0839

- 13.1.3 Each control tyre must only be allocated to a specific *Automobile* identified by its chassis/VIN number and with the exception of wear resulting from normal usage, each control tyre must remain unmodified except as detailed below:

- 13.1.3.1 A section of “build up” measuring a maximum of 50 mm across the entire tread may be removed from each tyre to allow the tyre tread depth to be measured at a maximum of 2 locations on any 1 tyre.
- 13.1.3.2 The removal of any additional “build up” to allow closer inspection of a control tyre must not be carried out without the prior express permission of the *TD*.
- 13.1.3.3 Other than as provided in this rule, tyre “build up” must not be removed from any control tyre during a *Round* by any means other than by driving.

- 13.1.3.4 The removal of tyre 'build up' is permitted between *Rounds*.
- 13.1.4 It is the responsibility of the *Competitor* to present a minimum of 4 tyres (2 front and 2 rear) to the *TD* for scanning prior to qualifying with the option to present up to an additional 4 tyres for scanning a minimum of 30 minutes prior to marshalling for any race during that *Round*. These scanned tyres are the only tyres permitted to be used on that *Automobile* during any qualifying session or race at that *Round*. Any previously scanned tyre must be re-scanned for use at the relevant *Round*.
- 13.1.5 The maximum number of new tyres permitted to be used at each *Round* is detailed in [Table S13.2](#) below.
- 13.1.6 For the entire *Series*, 12 (6 front and 6 rear) additional new tyres are allocated to a specific *Automobile* (identified by its chassis/VIN#) of which up to 4 (2 front and 2 rear) can be used as joker tyres during practice only at each *Round*. The use of 1 or more joker tyres must be announced to the *TD* prior to the commencement of practice. If an *Automobile* does not participate at 1 or more *Rounds*, the total number of joker tyres will be reduced by 2 (1 front and 1 rear) for each of these *Rounds*.
- 13.1.7 The number of "previously nominated" tyres is unlimited but may only be used as per [Table S13.3](#) below.
- 13.1.8 A previously nominated tyre is any tyre that has been scanned into the tyre bank for that specific *Automobile* during the 2023 *Series*.
- 13.1.9 For the first *Round* that an *Automobile* enters, a maximum of 8 (4 front and 4 rear) new or used tyres are permitted to be nominated as a previously nominated tyre. Only 4 (2 front and 2 rear) of these nominated tyres will be added to the tyre bank allocated to that specific *Automobile*.
- 13.1.10 The Porsche Cars Australia database of scanned tyres will be the official record of the 2023 tyre bank for each *Automobile*.
- 13.1.11 There will be no new replacement control tyres. Any replacement tyre must be marked for that *Automobile* at that *Round*. Permission to use a replacement tyre will be at the discretion of the *TD*.
- 13.1.12 Any replacement tyre approved for use by a Class A Pro *Automobile* must be marked for use on that *Automobile*. That *Automobile* must then start the next race at that *Round* with a 10 grid spot penalty.
- 13.1.13 Any replacement tyre approved for use by a Class A Pro-Am or Class B *Automobile* must be marked for use on that *Automobile*. That *Automobile* must then start the next race at that *Round* with a 5 grid spot penalty. A maximum of 2 front and 2 rear tyres can be replaced at a *Round* and a maximum of 4 front and 4 rear tyres may be replaced for the *Series*. Any further replacement tyres will result in that *Automobile* starting the next race at that *Round* from the rear of the grid.
- 13.1.14 Each new control tyre must only be mounted with the barcode facing outwards unless authorised by the *TD*. The *TD* will only authorise a tyre to be "turned" on the rim if they deem it is otherwise not useable. Any previously nominated tyre is free to be mounted in either direction.
- 13.1.15 It is prohibited to heat any tyre prior to a session. This includes the use of any device or chemical treatment or any other form of tyre heating which artificially varies the temperature in or of a control tyre, regardless of whether the control tyre is mounted on a wheel or not. Further, it is prohibited to fit a front wheel and tyre to the rear axle of an *Automobile* during powertrain warm up. If fitted to the *Automobile*, each wheel and tyre must be fitted in its respective position only.
- 13.1.16 The official tyre supplier will have 1 set of new wet tyres available for each *Automobile* at each *Round*. From the commencement of any session requiring the use of wet tyres a maximum of 2 sets of wet tyres may be used at that *Round*. These tyres may be allocated to that *Automobile's* tyre bank for that *Round*.

13.1.17 Unless otherwise approved by the *CM*, a *Driver* that changes *Automobile* or team during the *Series* will maintain the tyre bank of their initial *Automobile*...

### S13.2 Table New tyre usage

<i>Round</i>	<i>Practice</i>	<i>Warm Up</i>	<i>Qualifying and Races</i>
1	12 Joker Tyres	0	8
2		0	8
3		0	8
4		0	8
5		0	8
6		0	8

### S13.3 Table Previously nominated tyre usage

<i>Round</i>	<i>Practice</i>	<i>Warm Up</i>	<i>Qualifying and Races</i>
All	Yes	Yes	No

**Note:** The *TD* will be sole arbiter regarding the interpretation and application of these tyre regulations and any decision made by the *TD* in this regard will not be the subject of any protest or appeal.

## S14 FUEL

14.1 For the duration of an *Event*, each *Competitor* must only use the specified control fuel supplied by the official fuel supplier as detailed below or their appointed representative:

Race Fuels

Mark Tierney

BH: 0419 511 517

Email: info@racefuels.com.au

14.2 Approved containers as supplied by the official fuel supplier and as detailed in [ATTACHMENT B](#) must be used.

14.3 Any container used for storing or handling fuel must have the Hazard information as detailed in [ATTACHMENT B](#) affixed.

14.4 With the exception of ambient atmospheric air and the specified control fuel, no other substance may be added to the intake charge of the engine.

14.5 During any re-fuelling a minimum of 2 refuellers, of which 1 must be a fire attendant, must be present:

## S15 AUTOMOBILE MARKINGS

### S15.1 Exclusivity

15.1.1 It is prohibited to communicate advertising on an *Automobile* of any company or product that is in competition to Porsche Cars Australia, Porsche Motorsport global partners or the *Series*' title partner unless otherwise advised in writing by the *CM*.

15.1.2 The current status of official *Series* and cooperation partners can be requested from the *CM*.

## S15.2 Automobile Markings and Series Identification

- 15.2.1 In addition to the requirements detailed below and [Attachment A](#) of these regulations, each *Automobile* must comply with Technical Appendix, Schedule K of the *Manual*.
- 15.2.2 Each *Competitor* must display the *Series* sponsor decals as detailed in the table below and [Attachment A](#) of these regulations.
- 15.2.3 The *Series* sponsor decals will be supplied by the *CM*.
- 15.2.4 Any signage placed on an *Automobile* in the direct view of a TV Production on-board camera must comply with [Attachment C](#) and have the prior written approval of the *CM*.

Quantity	Size (mm)	Signage	Position on <i>Automobile</i>
1	557	MICHELIN	Centre / Top Front Bumper
1		Porsche Crest	Original Position Front Bonnet
2	230	Competition Numbers	Right Side Front Windscreen, Left Side Rear Windscreen
1	200	Reserved <i>PCA</i>	Front Top Windscreen Banner
1	160	Reserved <i>PCA</i>	Rear Top Windscreen Banner
2	80	<i>Driver's</i> Surname	Left / Right Door Window
2	60 x 260	Motorsport Australia logo	Left / Right Sill
2	61 x 361	MICHELIN	Left / Right of Rear Number Plate
2	45	<i>Driver</i> Classification	Left / Right Rear Side Window
2		Reserved <i>PCA</i>	Left / Right Mirror Covers
2		Reserved <i>PCA</i>	Left / Right Headlight
2		Reserved <i>PCA</i>	Left / Right Daytime Running Light
2		Reserved <i>PCA</i>	Left / Right Sill
1		Reserved <i>PCA</i>	Centre / Number Plate Rear Bumper
1	30 x 260	PORSCHE Logo	Original position, Centre Rear Panel
2	30	Website	Left / Right 'A' Pillar
2	120	Competition Numbers	Left / Right Rear Side Window

## S15.3 Competition Number

The allocation of a competition number for each *Automobile* is solely the responsibility of the *CM*, which will maintain a register of all competition numbers allocated to, or reserved for, any *Automobile*.

## S16 DRIVER APPAREL

### S16.1 Standard of Apparel

Each *Driver* must wear apparel that complies with "National" in Table 2.1 of Technical Appendix, Schedule D of the *Manual*.



## S16.2 Reserved Signage on Racing Overalls

### PORSCHE MICHELIN SPRINT CHALLENGE AUSTRALIA

Race Suit Signage Regulations



## S17 TESTING RESTRICTIONS

Unless approved by the *CM* in writing, testing of any competition *Automobile* and/or *Driver* deemed to be associated with the *Series* is prohibited on any *Circuit* during the 7 days preceding a *Round* at that *Circuit*, other than private sessions sanctioned by the *CM*. For clarification, the 7 days commences at 0001 hours on the Saturday preceding the scheduled *Round*.

## S18 RAIN LIGHT

The rain light fitted to each *Automobile* must be illuminated at all times when the *Automobile* is running on wet-weather tyres or as directed by Race Control via the *RMC*.

## S19 IN-CAR CAMERAS

### S19.1 In-Car System

- 19.1.1 Each *Automobile* must be fitted with an on-board camera and its installation must be approved by the *TD* and Chief Scrutineer.
- 19.1.2 Each *Competitor* must ensure that the camera is switched on and functioning in the correct manner prior to the *Automobile* entering the *Track* for each practice, *Passenger* ride, qualifying, warm up and race session at an *Event*.
- 19.1.3 When requested, a Team must immediately provide the USB storage device to the *DSA*, Clerk of the Course or Stewards.
- 19.1.4 A Team is prohibited to remove the USB storage device while the *Automobile* is under *Parc Fermé* conditions.

### S19.2 TV Production Cameras

The *CM* reserves the right to install TV production in-car and on-board cameras on an *Automobile* and position signage within view of the camera (refer [Attachment C](#)).

## S20 GROUND CLEARANCE

There are no restrictions for the adjustment of ride height at any time but it may not be adjusted by the *Driver* while in the *Cockpit*.

## S21 ABS

ABS is prohibited

## S22 TELEMETRY, DATA RECORDING SYSTEMS

- 22.1 At any time during a *Round*, the *TD* or the *TA* and/or Stewards have the right to request and receive from a *Competitor* or *Automobile*, recorded *Automobile* data. This data may be analysed and provided to the Stewards for use as evidence in any inquiry or hearing.
- 22.2 The use of laptops/computers connected to the *Automobile* is prohibited during qualifying and the races from the time the *Automobile* enters the marshalling area until the *Automobiles* are released from *Parc Fermé*.

## S23 DRY TO WET PROCEDURE

### S23.1 Prior to *Automobiles* being called to the marshalling area

If the *Track* is declared wet prior to *Automobiles* being called to the marshalling area, Articles S23.2 and S23.3 will not apply.

### S23.2 Before the race *Start*

- 23.2.1 If the *Track* conditions change from dry to wet, to the point that wet tyres are required, after the *Automobiles* have left the marshalling area but prior to the race *Start*, all *Automobiles* will be directed to the *Pit Lane*.
- 23.2.2 The only work permitted to be carried out on an *Automobile* while in the *Pit Lane* will be changing to wet tyres.
- 23.2.3 On completion of all *Automobiles* changing to wet tyres, each *Automobile* will proceed to the grid as instructed over *RMC*.

### S23.3 During the race

- 23.3.1 If the *Track* conditions change from dry to wet, to the point that wet tyres are required during the race, the Safety Car will be deployed.
- 23.3.2 If it is determined that the *Track* will not dry quickly and less than 75% of the race distance has been completed, the race will be suspended with all *Automobiles* directed to the *Pit Lane*.
- 23.3.3 The only work permitted to be carried out on an *Automobile* in the *Pit Lane* will be changing to wet tyres.
- 23.3.4 On completion of all *Automobiles* changing to wet tyres, the order in which *Automobiles* are to line up behind the Safety Car at pit exit will be announced over *RMC*.
- 23.3.5 The *Start* procedure for resuming the race will be as detailed in the *CRSR*.
- 23.3.6 If it is determined that the *Track* will not dry quickly and 75% or more of the race distance has been completed, the race will be stopped and not restarted.

## S24 PASSENGER RIDES

Any *Passenger* ride conducted must comply with the Motorsport Australia MSPRA Policy.

## S25 PORSCHE AUSTRALIA CODE OF CONDUCT

25.1 The Porsche Michelin Sprint Challenge Australia Series is a racing series characterised by equality of opportunity and fairness – in both technical and sporting terms. Those involved in the Porsche Michelin Sprint Challenge Australia Series (*Participants*, i.e. teams with all employees and team members, *Drivers*, officials, organisation) make a significant contribution to how the *Series* is perceived – both internally and by the general public – and to the atmosphere in the Porsche Michelin Sprint Challenge Australia Series through their conduct and their communication.

All those involved are responsible for conducting themselves in such a way as to uphold and safeguard in the long term the professionalism that prevails in the Porsche Michelin Sprint Challenge Australia Series, as well as the esteem in which the *Series* and its *Participants* are held by the general public. Moreover, fair and sporting *Competition* represents an important safety aspect for all *Participants* and is intended to avoid risk factors.

For this reason, all those involved agree to acknowledge the philosophy of the Porsche Michelin Sprint Challenge Australia Series and to comply with the rules of conduct of the *Series*.

25.2 Both on and also adjacent to the *Track*, all those involved will:

treat the other *Participants*, officials and *Organiser* respectfully; and

follow the laws and the rules of the sport, and exemplify and promote fairness and the rules of conduct; and

neither express themselves or behave in an insulting, offensive or abusive way, nor tolerate such expressions or modes of conduct, either in direct conversations, interviews, etc. or in other communication, e. g. press releases, posts in social media, etc.; and

always behave in the interests of safety and permanently cooperate in efforts to reduce risks; and

use resources in a sustainable way, giving priority to the well-being, safety and satisfaction of others before their own personal goal; and

always comply with the purpose of the sport; and

point out to other people who are involved if their conduct is not characterised by fairness, sportsmanship, respect and tolerance; and

cooperate with all other persons involved so as to develop and improve the *Series* and its status further on a continuous basis.

25.3 As a consequence of failing to comply with the rules of conduct, *Participants* who:

(repeatedly) infringe against the Regulations; or

draw attention to themselves through unsporting behaviour on and adjacent to the *Track*; or

express themselves about or behave in a disrespectful way towards other *Participants*, officials, organisers, etc.; or

ignore the specifications, instructions, meetings of the *Series* organisation and/or other official bodies in the context of the organisation and holding of an *Event*; or

ignore agreements that have been reached (including between teams and *Drivers*) and do not meet obligations of performance; or

do not act in the interests of the sport and/or the recognisable objective of undertaking the activities seriously in accordance with the *Rules* that have been acknowledged;

may be excluded from the Porsche Michelin Sprint Challenge Australia Series.

25.4 Continued participation in this *Series* may be prohibited until any fine imposed is paid in full.

## ATTACHMENT A

### AUTOMOBILE MARKINGS

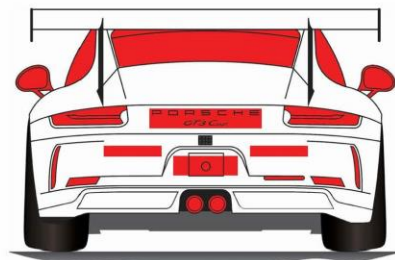
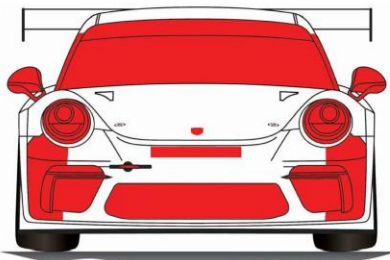
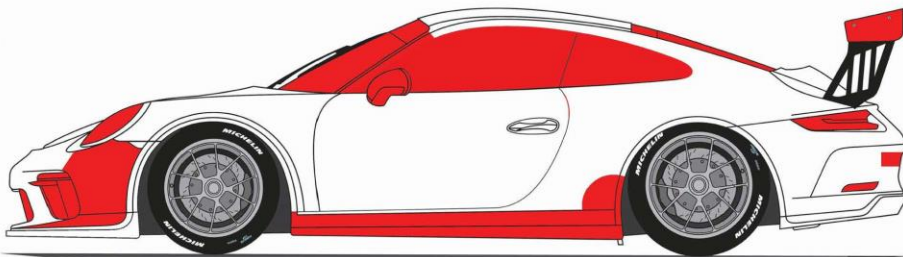
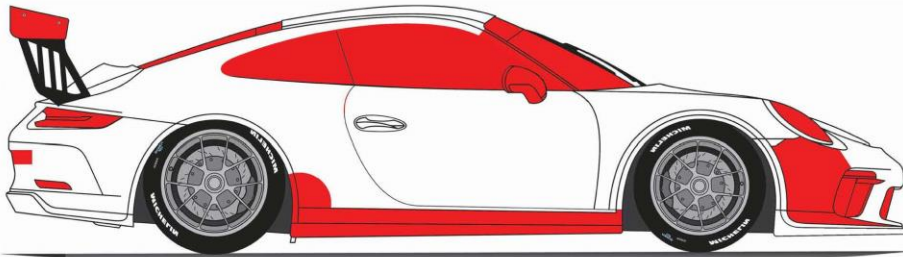
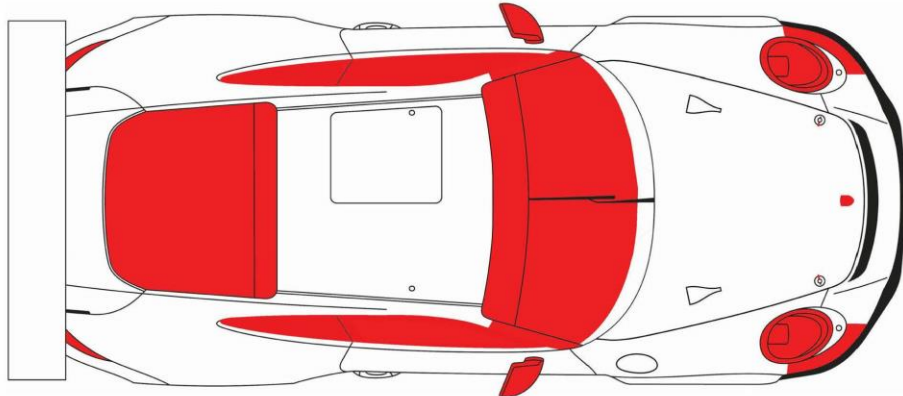

**ATTACHMENT B**  
**FUEL CONTAINER**



## ATTACHMENT C

### IN-CAR CAMERA RESERVED SIGNAGE



The area indicated on the dash in white (400 mm x 85 mm) is allocated to *Competitors* for the use of personal sponsors.

No other *Competitor* signage is permitted.

## GENERAL TECHNICAL REGULATIONS

### T1 PREAMBLE

Unless expressly permitted in these regulations, modification to the standard specification of the *Automobile* as supplied by Porsche Cars Australia (*PCA*) is strictly prohibited. In the event of any dispute, parts or specifications of the *Automobile* in question will be compared against parts and/or specifications supplied by *PCA*. *PCA* reserves the right to update part numbers from time to time as they are superseded.

### T2 PRINCIPLES OF THE TECHNICAL REGULATIONS

- 2.1 Each *Automobile* must comply with all requirements of each of the below unless they are clearly specified as being optional:
  - 2.1.1 Articles 251 and 277 (Group EII-SH) of Appendix J to the *Code*;
  - 2.1.2 These Technical Regulations;
  - 2.1.3 Technical Manual/s of the eligible *Automobile*;
  - 2.1.4 Technical information of Dr. Ing. H.c. F. Porsche AG;
  - 2.1.5 Software information of Dr. Ing. H.c. F. Porsche AG;
  - 2.1.6 Spare parts catalogue/s of the eligible *Automobile*;
- 2.2 If there is any discrepancy between the requirements of these Technical Regulations and any relevant technical manual, technical information, software information or parts catalogue, then these Technical Regulations will take precedence.
- 2.3 Any requirement specified in a technical manual, technical information, software information and/or parts catalogue may be updated by Dr. Ing. H.c. F. Porsche AG at any time.
- 2.4 For software information, only the latest version is valid. However, “setups” (based on the latest version) may be varied within the parameters permitted by Dr. Ing. H.c. F. Porsche AG. Any requirement may be varied for any specific *Competition* by means of a Bulletin issued by the Stewards.
- 2.5 It is recognised that a spare part listed in a parts catalogue may be subject to a change of part number during the *Series*. Therefore, subject to prior approval by Dr. Ing. h.c. F. Porsche AG Aftersales Department, a spare part which is identical to that shown in the parts catalogue (and which has the same function, working principle and location in the *Automobile*) but which bears a different part number may be used. Such approval will be at the sole discretion of Dr. Ing. h.c. F. Porsche AG and it is the responsibility of the *Competitor* to ensure such approval, where granted, is documented and retained for inspection by the *TD*.

### T3 ELIGIBILITY

#### T3.1 Eligible *Automobiles*

- 3.1.1 Only Porsche Carrera Cup GT3 Type *Automobiles* as listed in the table below will be eligible to participate in the 2023 Porsche Michelin Sprint Challenge Australia Series.



### 3.1.2 List of Eligible *Automobiles*

<b>Class A</b>	Porsche 911 GT3 Cup Type 991 Gen II (MY17-20)
<b>Class B</b>	Porsche 911 GT3 Cup Type 991 Gen I (MY13-16)

3.1.3 Each GT3 Cup Type 991 Gen II (MY17-20) *Automobile* must be registered with the *CM* and must be the subject of a current Race Vehicle Authorisation Certificate (RVAC) issued by *PCA*.

3.1.4 For specifications for Porsche 911 GT3 Cup Type 991 Gen II (MY17-20) and GT3 Cup Type 991 Gen I (MY13-16) *Automobiles* refer to [ATTACHMENT D](#).

### T3.2 Original Components

3.2.1 In these regulations the term “original” when applied to a component part, means the genuine “Porsche” component and must remain identical to the original manufacturers’ design specifications and be used in the manufacturers intended manner.

3.2.2 Any item not specifically referred to in these regulations is required to be as originally fitted to the *Automobile*.

### T3.3 Examination for Eligibility

3.3.1 The presentation of an *Automobile* for participation in any *Round* will be deemed to be an implicit statement by the *Competitor* of conformity with these Technical Regulations.

3.3.2 Should the Technical Delegate (*TD*) suspect at any time that an *Automobile* does not comply with these Technical Regulations, the *Competitor*, or nominated representative, must be so advised and given the opportunity to comment on the suspected or alleged ineligibility.

3.3.3 Any comment so made may be recorded by the *TD*, and subsequently may be presented at any Stewards’ Inquiry or Hearing.

3.3.4 Should the *TD* fail to receive an adequate comment on the suspected or alleged ineligibility, which the *TD* alone has sole discretion to consider as adequate or satisfactory, the *TD* may require the *Automobile* to be impounded and examined, including such dismantling as may be necessary, to determine the points of eligibility in question.

3.3.5 At the discretion of the Stewards and/or the *TD*, any component, part or *Automobile* may be sealed by the *TD* for later examination.

## T4 SCRUTINEERING

### T4.1 Onus on *Competitor*

4.1.1 The onus is on the *Competitor*, or their nominated representative, to present their *Automobile* for scrutineering at the appropriate times, in a complete and finished state, in ‘ready to race’ condition including each marking and *Seal* on the *Automobile* in accordance with the Sporting Regulations and Technical Appendix, Schedule K of the *Manual* and an operating timing transmitter in position on the *Automobile*.

4.1.2 The presentation by the *Competitor* of their *Automobile* for scrutineering will be deemed an implicit statement of conformity with the *Rules*.

### T4.2 Scrutineering and Technical Checks

4.2.1 Before and, as required, during or after each *Competition*, each *Automobile* will be inspected by the *TD* or their nominee. Any *Automobile* or part of an *Automobile* can be selected at any time by the *TD* or if requested, by the Stewards for a further examination, including examination outside of the *Event*.

- 4.2.2 The *TD* is entitled to check any aspect of an *Automobile* at any time during an *Event*.
- 4.2.3 The *TD* or their nominee is responsible for the operation of *Parc Fermé* and are the only officials authorised to provide instructions in this respect to a *Competitor*.
- 4.2.4 Each *Competitor* and *Driver* must at all times follow any instruction of the *TD* regarding the checking and re-inspection of their *Automobile*.
- 4.2.5 *Automobile* and *Drivers*' safety equipment must be shown to the *TD* or their nominee for technical and visual examination during the stated inspection period/s.
- 4.2.6 Any *Automobile* provided with permission to leave the paddock (refer Article S12.8) must be presented again to the *TD* before taking any further part in the *Competition*. It is the *Competitor's* responsibility to present the *Automobile* to the *TD*.

#### **T4.3 Subsequent Scrutineering**

- 4.3.1 After each qualifying session and race, each *Automobile* must be brought to the *Parc Fermé* by the route described in the Driver Briefing Instructions by the *Driver* in full racing equipment.
- 4.3.2 Each *Automobile* is subject to *Parc Fermé* conditions until released by the *TD* or the Stewards. During this time, no work of any kind may be performed on an *Automobile*.
- 4.3.3 Once in *Parc Fermé*, it is prohibited to remove an *Automobile* without the permission of the *TD* / Stewards.
- 4.3.4 An *Automobile* that has been involved in an incident at any time during an *Event* must be presented to the *TD*. Any repairs identified by the *TD* must be undertaken by the *Competitor* and the *Automobile* represented to the *TD*. It is the *Competitor's* responsibility to do so before taking part in the *Competition* again.
- 4.3.5 Any *Automobile* that is permitted to leave the paddock for repairs after an incident must be presented again to the *TD* before taking any further part in the *Competition*. It is the *Competitor's* responsibility to present the *Automobile* to the *TD*.

#### **T4.4 Targeted Scrutineering**

Scrutineering at each *Round* will be conducted according to the Targeted Scrutineering Procedures published by *Motorsport Australia*.

## **T5 COCKPIT**

#### **T5.1 Safety Cage**

- 5.1.1 The safety cage as supplied by Porsche is mandatory and must not be modified.
- 5.1.2 The Safety Cage must comply with the requirements of Technical Appendix, Schedule J of the *Manual*.

#### **T5.2 Windscreens**

- 5.2.1 It is prohibited to fit after-market windscreen heater strips.
- 5.2.2 It is permitted to fit windshield protection tear-offs.

#### **T5.3 Pit Lane Speed Limiter**

The pit lane speed limiter must be activated at all times whilst the *Automobile* is moving in pit lane.

**Note:** Regardless of the pit lane speed limiter, each *Driver* always remains responsible for ensuring that the pit lane speed limit is not exceeded.

#### **T5.4 Seat**

- 5.4.1 The *Driver's Seat* may be replaced by another of a type homologated by the FIA to the 8855-1999 or the 8862-2009 standard.
- 5.4.2 The original mounting (track) must be retained, unless specifically approved otherwise by the *TD*.
- 5.4.3 The floor of the *Automobile* must not be modified in any way and the original mounting holes must be used.
- 5.4.4 Any *Seat* complying with FIA 8862-2009 standard must use the homologated seat mounts.

#### **T5.5 Safety Harnesses**

A minimum '5 point' FIA homologated safety harness complying with Technical Appendix, Schedule I of the *Manual*, which is suitable for use with a head and neck restraint system is mandatory.

#### **T5.6 Window Nets**

Each Class A *Automobile* must be fitted with the after sales window net as specified in the valid spare parts catalogue and mounted in compliance with the official Dr. Ing h.c. F. Porsche AG mounting instructions.

#### **T5.7 Cool Suit Associated Components**

- 5.7.1 It is permitted to fit a cool suit system to the *Automobile*.
- 5.7.2 The cool suit system may form part of the *Ballast* of the *Automobile*.
- 5.7.3 The mounting of cool suit associated component hardware is to be located wholly within the *Cockpit*.
- 5.7.4 The cool suit cooler unit must only be mounted to the *Passenger* side floor using the original seat mount holes.
  - 5.7.4.1 The original cooler unit mounting bracket must be used.
  - 5.7.4.2 It is permitted to fabricate a mounting plate between the original seat mount holes and the original cooler unit mounting brackets.
  - 5.7.4.3 Any mounting system must be capable of sustaining a force of 30G in an incident.

#### **T5.8 Drink Bottle**

- 5.8.1 A drink bottle may be fitted for the *Driver's* hydration.
- 5.8.2 The bottle and associated plumbing are to be located wholly within the *Cockpit* and must not exceed 2 litres in capacity.
- 5.8.3 Only 1 drink bottle is permitted per *Automobile*.
- 5.8.4 The drink bottle must only be of proprietary manufacture and securely mounted behind the *Driver's Seat* and to the satisfaction of the *TD*.

#### **T5.9 In-Car Cameras**

In-car cameras are permitted, subject to their installation being approved by the *TD* and Chief Scrutineer.

#### **T5.10 Timing Transmitters**

The location of the Dorian Data 1 transmitter must be in the recessed section of the right rear floor pan, directly behind the right rear air jack. See diagram attached at [ATTACHMENT E](#).

#### **T5.11 Fire Extinguisher**

- 5.11.1 The fire extinguisher system compliant with FIA Article 253.7.2 of Appendix J to the International Sporting Code, as supplied originally with the *Automobile* and its installation position must remain unchanged.
- 5.11.2 The fire extinguisher system must be switched into position "Armed" and the red LED flashing from the moment the *Automobile* leaves its team pit garage to travel to the marshalling area for each session and must not be switched off until the *Automobile* is returned to the team pit garage or *Parc Fermé* after the session.

### **T5.12 Coachwork**

The *Coachwork* must remain as supplied by the factory.

### **T5.13 Ventilation**

5.13.1 Any ventilation duct must remain as originally supplied except that it is permitted to cover the front bonnet *Driver* ventilation duct and/or the rear side window openings with clear tape, only when the *Automobile* is fitted with wet weather tyres or by approval of the *TD*.

5.13.2 Additional ventilation is permissible through windows only, however, this must not protrude past the external part of the *Automobile*.

### **T5.14 Air Intake Blanking**

5.14.1 Class A Automobile

5.14.1.1 It is prohibited for air intakes in the front bumper bar to be partially or completely blanked.

5.14.2 Class B Automobile

5.14.2.1 It is permitted for air intakes in the front bumper bar to be partially or completely blanked.

5.14.2.2 Race tape, preferably black in colour, is the only material able to be used to facilitate such blanking.

5.14.2.3 Blanking tape must be fitted from top to bottom and may only be removed starting from the bottom most surface to obtain the desired coolant temperature.

## **T6 TRANSMISSION**

6.1 The ramp angles are 52° (drive) and 35° (coast), refer to [ATTACHMENT F](#).

6.2 The minimum locking torque of the differential measured at the wheel nut with a blocked meshing gear is 65 Nm.

## **T7 ENGINE TYPE**

Unless with the prior written approval of the *CM*, the engine must respect the year model of the *Automobile* at all times, refer to [ATTACHMENT D](#).

## **T8 ENGINE AND TRANSMISSION REPAIRS**

8.1 All work involving the following items and/or breaking of *Seals* is only to be conducted once formal written approval is given by the *TD*, refer [ATTACHMENT H](#)

8.1.1 Crankcase

8.1.2 Crankshaft

8.1.3 Pistons

8.1.4 Cylinder head

8.1.5 Camshaft

8.1.6 Gearbox

8.1.7 Differential

- 8.2 Once the *CM* and the *TD* are satisfied that the appropriate procedures for repair have been complied with, the *TD* will fit any required *Seal*.
- 8.3 The above protocol is to ensure continuity and parity between *Automobiles*. This is an essential ingredient in the success of the *Series*.
- 8.4 Any breach of the above direction will be referred to the Stewards.

## T9 SEALS

- 9.1 The *TD* will supply and fit engine and gearbox *Seals* to each *Automobile* determined to be eligible to compete. These *Seals* will be fitted to the camshaft housing covers on the right and left hand sides of the engine, differential housing and gearbox housing.
- 9.2 The ultimate responsibility to ensure each correct *Seal* is fitted prior to any *Track* activity rests solely with the *Competitor*.
- 9.3 The *Competitor* of an *Automobile* found not to have the correct *Seal/s* fitted or if it is determined that a *Seal* has been tampered with, may be referred to the Stewards.
- 9.4 Save that written advice has been forwarded to the *TD* and the *TD* has given written permission for the *Seals* to be removed, the *Competitor* of an *Automobile* found not to have *Seal/s* fitted may be referred to the Stewards.
- 9.5 At all times, the *TD* will be a Judge of Fact in respect of any *Seal* fitted to an *Automobile*.

## T10 SUSPENSION

### T10.1 Suspension

- 10.1.1 The suspension may be adjusted within the existing tolerances.
- 10.1.2 All original parts, including replacement parts, must be retained in their original fitted location.
- 10.1.3 The maximum permissible thickness of shims on the control arms are listed in the Table below:

	Front Axle	Rear Axle
Type 991 Gen I & II	18 mm	15mm
Phillip Island Circuit only		
Type 991 Gen I & II	14 mm	12 mm

- 10.1.4 The diagonal link mounting points on each front control arm must be retained at the factory position (shortest wheel base). Middle position is prohibited.

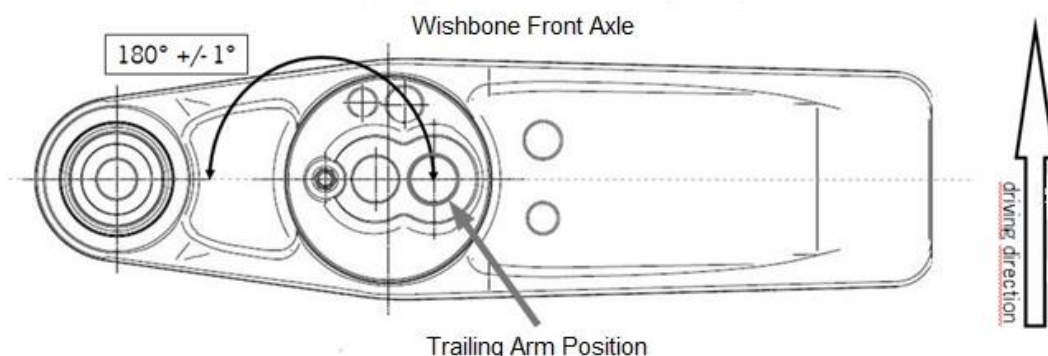

## **T10.2 Damper/Springs**

10.2.1 Sachs suspension dampers with the following Part numbers are the only permissible suspension dampers:

10.2.2 As originally supplied, H & R brand with the following Part numbers are the only permissible suspension springs.

	<b>Front</b>	<b>Rear</b>
Sachs Damper	991.343.145.8D	991.333.051.8A
Main 240/60/120	991.343.531.8C	
Tender 75/60/42	996.343.537.90	
Main 260/60/130		991.333.531.8C
Tender 80/60/60		997.333.537.90

10.2.3 The original delivery condition of the bump stops of the front and rear dampers must not be modified in any way.

10.2.4 The *TD* may, at any time, request the removal of the dampers and springs from any *Automobile* for the purposes of testing and/or eligibility checking. The *TD* may require the dampers and springs to be taken to another location for further testing.

## **T10.3 Ground Clearance**

There are no restrictions for the adjustment of ride height at any time but may not be adjusted by the *Driver* while in the *Cockpit*.

## **T10.4 Anti-Roll bars**

Under the condition that no parts are removed from the *Automobile*, the disconnection of the anti-roll bars is permissible. Only the technically available adjustment positions may be used.

# **T11 TELEMETRY, DATA RECORDING SYSTEMS AND ECU**

## **T11.1 Telemetry**

The use of telemetry is prohibited.

## **T11.2 Data Recording Systems**

11.2.1 The Cosworth data acquisition system as supplied originally with the *Automobile* is the only data acquisition system permitted.

11.2.2 This system must be installed as original without modification.

11.2.3 Unless otherwise approved by the *CM*, the Cosworth system is assigned to the VIN/Chassis Number and must not be exchanged.

## **T11.3 ECU and Wiring Loom**

11.3.1 The Bosch Motronic MS4.6 NG electronic control unit including the complete wiring loom must be used without being changed.

11.3.2 The *TD* reserves the right to check or exchange the Bosch electronic control unit. The *CM* reserves the right to reprogram the Bosch electronic control units at any time during a *Round*. This is to ensure that the status of the program and data is identical for each participating *Automobile*.

#### T11.4 Verification – ECU Data Monitor

- 11.4.1 At any time the *TD* may fit a data monitor to an *Automobile*. The ECU data monitor is supplied by the *CM* and the wiring harness is fitted standard to each *Automobile*.
- 11.4.2 Each *Competitor* is responsible for ensuring that the wiring and sensors that provide signals to the ECU data monitor are adequately maintained and remain working at all times.
- 11.4.3 Any cost of rectifying damage (whether accidental or otherwise) to the ECU data monitor while in the possession of a *Competitor* is the responsibility of the *Competitor* and the cost of any damage will be assessed by the *CM*.
- 11.4.4 The *TD* will make all decisions in relation to all determinations regarding the installation and operation of the ECU data monitor and any interpretation arising therefrom.
- 11.4.5 ECU data logging by any *Competitor* and/or *Driver* is prohibited.

## T12 WHEELS

Only the *Wheels* as detailed in the ATTACHMENT D are permitted.

## T13 RACING WEIGHT

- 13.1 Each *Automobile* must achieve a minimum *Racing Weight* as outlined in the table below.

Model	Minimum <i>Racing Weight</i> (including <i>Driver</i> )
GT3 Cup Type 991 Gen II (MY17-20)	1300 kg
GT3 Cup Type 991 Gen I (MY13-16)	1300 kg

- 13.2 Weight may be checked after each official qualifying session and after each *Series* race on the scales provided by the *CM* at each venue. The weight recorded on these scales will be considered to be fact and will not be the subject of any Appeal or Protest.
- 13.3 Each *Automobile* that records a weight less than the stipulated minimum will incur a penalty. The penalty for the first breach will be *Disqualification* from the results of that session. The penalty for any subsequent breach of the minimum weight may include *Disqualification* from the *Event*.
- 13.4 *Ballast* Location: *Ballast* may only be fitted to the *Passenger* floor of the *Cockpit* in accordance with the Technical Appendix, Schedule A of the *Manual* and to the satisfaction of the Chief Scrutineer.
- 13.5 Unless performed by the *TD*, it is prohibited to add or remove any substance to/from an *Automobile* after it has been selected to be weighed. The same applies during the weighing process and after the end of the race.
- 13.6 It is the *Competitor's* responsibility to ensure that their *Automobile* can be brought directly to the weighing area when instructed by the *TD* at any time during the *Event*. In any case, *Parc Fermé* rules apply to the *Automobile* from the announcement of the requirement to be weighed until the completion of the weighing process.
- 13.7 If during any post session weighing procedure, the combination of *Automobile* and *Driver* (including *Driver* equipment) is found to be below the currently applicable minimum weight, the *Automobile* will immediately be weighed for a second and a third time on the same scales and in the same condition after the same session and with the same measuring method. The maximum value of the 3 weights recorded will be regarded as the actual weight for the combination of *Automobile* and *Driver* (including *Driver* equipment).

## T14 LUBRICANTS

### T14.1 Engine Oil

Mobil 1 0W40 or ESP X3 0W40 engine oil is recommended.

### T14.2 Gearbox Oil

Mobilube 1 SHC 75W90 gear oil is recommended.

## T15 FUEL SYSTEM

- 15.1 A dry-break fuel system may be fitted as per Technical Appendix, Schedule N of the *Manual*.
- 15.2 Only the control fuel as per S14.1 may be used at the *Event*.
- 15.3 The *TD* may take fuel samples from an *Automobile* at any time during a *Round*.
- 15.4 With the exception of ambient atmospheric air and the specified control fuel, no other substance may be added to the intake charge of the engine.

## T16 REAR SPOILER

The position of the rear spoiler profile may be changed within the prescribed adjustment range.

## T17 FRONT LIP

- 17.1 For Type 991 Gen II (MY17-20) *Automobiles*, front lip Part No. 9F0807061 must be used.
- 17.2 For Type 991 Gen I (MY13-16) *Automobiles*, front lip Part No: 991.505.557.8A must be used.

## T18 EXHAUST SYSTEM

- 18.1 Exhaust System Nr 1 ('Supercup' system) is to be fitted as standard and Exhaust System Nr 2 (centre rear muffler and attachments) must be taken to all rounds. Refer [ATTACHMENT G](#).
- 18.2 Unless specified otherwise in the Event Regulations for a specific *Round*, the exhaust system to be fitted at each *Round* must be as per the table below.

Round	Circuit	Exhaust System
1	Phillip Island	Nr 2
2	Queensland Raceway	Nr 1
3	Symmons Plains Raceway	Nr 1
4	Sydney Motorsport Park	Nr 1
5	The Bend Motorsport Park	Nr 1
6	Mount Panorama	Nr 1

## T19 COOLING SYSTEM

- 19.1 Where Glycol based corrosion protection is used, the volume of corrosion protection added must be limited to a maximum of 12% of the cooling system capacity.



- 19.2 The cooling system capacity is 22 litres, therefore the recommended fill method is 20 litres water plus 2 litres corrosion protection.
- 19.3 The *TD* may take samples and test concentration at any time during a *Round*.
- 19.4 Corrosion protection Part Number 997 106 907 90 is recommended.

## **T20 BRAKES**

Only brake components supplied by *PCA* or authorised supplier are permitted to be used.

## **T21 STEERING**

Only 1 hub extension, providing a 20 mm extension (part number 99734728790) is permitted to be fitted between the steering quick coupler and the steering column.

## ATTACHMENT D

### RECOGNITION DOCUMENT

PORSCHE MICHELIN SPRINT CHALLENGE AUSTRALIA SERIES  
 APPROVED VEHICLE SPECIFICATION RECOGNITION DOCUMENT

This form details the approved specifications of individual *Automobile* models and will be referred to as the “Recognition Document”.

**Model Type:** Porsche 911 GT3 Cup Type 991 Gen I/ Gen II  
**Model Year:** MY17-20 / MY13-16

#### SECTION 1 - CHASSIS

1.1 CHASSIS FRAME		
Description	Monocoque integrated chassis and body	
Manufacturer	Porsche	
Material	Aluminium and steel composite	
1.2 FRONT SUSPENSION		
Description	McPherson Strut – Type Axle, Height Adjustable	
Spring Medium	Double coil springs (main and helper springs)	
Damper Type	Sachs – Oil/Gas	Adjustable: No
Anti-sway Bar	Steel – Double blade type	Adjustable: Yes
Suspension Adjustable	Height - Via spring seat	Method: Thread
1.3 REAR SUSPENSION		
Description	Multi-Link with Solid Mounted Sub frame	
Spring Medium	Double coil springs (main and helper springs)	
Damper type	Sachs – Oil/Gas	Adjustable: No
Anti-sway Bar	Steel – Double blade type	Adjustable: Yes
Suspension Adjustable	Height - Via spring seat	Method: Thread
1.4 STEERING		
Type	Rack and pinion	Make: Porsche
1.5 BRAKES		
	Front	Rear
Type	Disc	Disc
Dimensions	380 x 32	380 x 30
Part Number	Left: 9913511058A      Right: 99113511068A	Left: 9913521078A      Right: 9913521088A
Material of disc	Multi piece steel	Multi piece steel
No. Pistons per Caliper	6	4
Actuation	Hydraulic	Hydraulic
Caliper	Porsche	Porsche
Adjustable Bias	Yes	
Brake Booster Fitted	No	
Brake Pads	Brand: PFC Part No: 9913519428A	Brand: PFC Part No: 9913529428A

## SECTION 2 - ENGINE

2.1 ENGINE		Gen II		Gen I	
Make	Porsche		Porsche		
Model	MA178		97/98		
No. and config.	Flat six (6)		Flat six (6)		
Cylinder Block Material	Aluminium		Aluminium		
Bore - original	102 mm		102.7 mm		
Stroke - original	81.5 mm		76.4 mm		
Capacity - original	3996 cc		3797 cc		
Cooling Method	Liquid		Liquid		
2.2 CYLINDER HEAD					
Make	Porsche		Porsche		
No. Valves Per Cylinder	Inlet: 2	Exhaust: 2	Inlet: 2	Exhaust: 2	
No. Ports Total	Inlet: 6	Exhaust: 6	Inlet: 6	Exhaust: 6	
No. Camshafts	Inlet: 2 chain driven	Exhaust: 2 chain driven	Inlet: 2 chain driven	Exhaust: 6 chain driven	
Valve Actuation	Bucket with hydraulic lifters		Bucket with hydraulic lifters		
Spark Plugs Per Cyl.	1		1		
2.3 LUBRICATION					
Method	Dry sump		Dry sump		
Oil Tank Location	Front of engine		Front of engine		
Dry Sump Type	Gear		Gear		
Location	Crankcase and cylinder heads		Crankcase and cylinder heads		
Oil Cooler	Yes		Yes		
Location	Mounted on engine		Mounted on engine		
2.4 IGNITION					
Type	Coil on plug		Coil on plug		
Make	Porsche		Porsche		
2.5 FUEL FEED					
Fuel Injection System	Model MS4.6	991.618.603.88	Model MS4.6	9916186828A	
Make	Porsche	Motronic/Bosch	Porsche	Motronic/Bosch	
Injector	Porsche EV6C	9A11.092.892	Porsche EV6C	99760513291	

## SECTION 3 - TRANSMISSION

3.1 CLUTCH		
Make	Porsche	
Type	Diaphragm	
No. of Plates	3 Friction, 3 Pressure	Assembly: 991.116.001.9A Friction: N/A
Components	3 Friction Plates	Part No: 9971161139A
	2 Intermediate Plates	Part No: 9971161259A
	1 Pressure Plate	Part No: 9971161239A
	1 Basket	9911160119A
Actuation	Hydraulic	

3.2 TRANSMISSION		
Type	Manual sequential	Rear wheel drive
Make	Porsche	
Model	G91/70	
No. Forward speeds	6	
1	13/41	3.154
2	17/40	2.353
3	19/36	1.895
4	19/29	1.526
5	24/30	1.250
6	34/35	1.029
3.3 FINAL DRIVE		
Differential Make: Porsche	Ramp Angle: 52° Drive & 30° Coast	
Wheel drive methods	Hypoid crown wheel and pinion	
Ratios	14/22 1.571	
Comments	Oil cooler and pump fitted standard	
3.4 TRANSMISSION SHAFTS (EXPOSED)		
Description	CV type shafts	
Part No	9913320248L	
3.5 WHEELS AND TYRES		
Wheel Type	Porsche	Material: Aluminium
Fixture Method	Centre Lock	
Wheel Rim	Front	Rear
	Part No: 991.362.131.8A	Part No: 991.362.151.8A
	10.5J x 18 – 28 mm offset	12J x 18 – 53 mm offset

#### SECTION 4 - GENERAL

4.1 FUEL SYSTEM		
Tank Location	Front	Capacity: 100 litres
Fuel Pump type and location	Electric internal	Make: Porsche
4.2 ELECTRICAL SYSTEM		
Voltage	12 volts negative ground	
Alternator fitted	Part No: 9A260301800	
Battery Location	Passenger foot well	Part No: 999.611.070.12
4.3 BODYWORK		
Type	Coupe	
Material	Smart aluminium - steel composite	
4.4 DIMENSIONS		
Wheelbase	Gen II 2456 mm +/- 15 mm	Gen I 2463 mm +/- 15 mm

## ATTACHMENT E

### LOCATION OF TIMING TRANSMITTER (FLOOR PAN REMOVED)



## ATTACHMENT F

### DIFFERENTIAL LOCK RAMP ANGLES

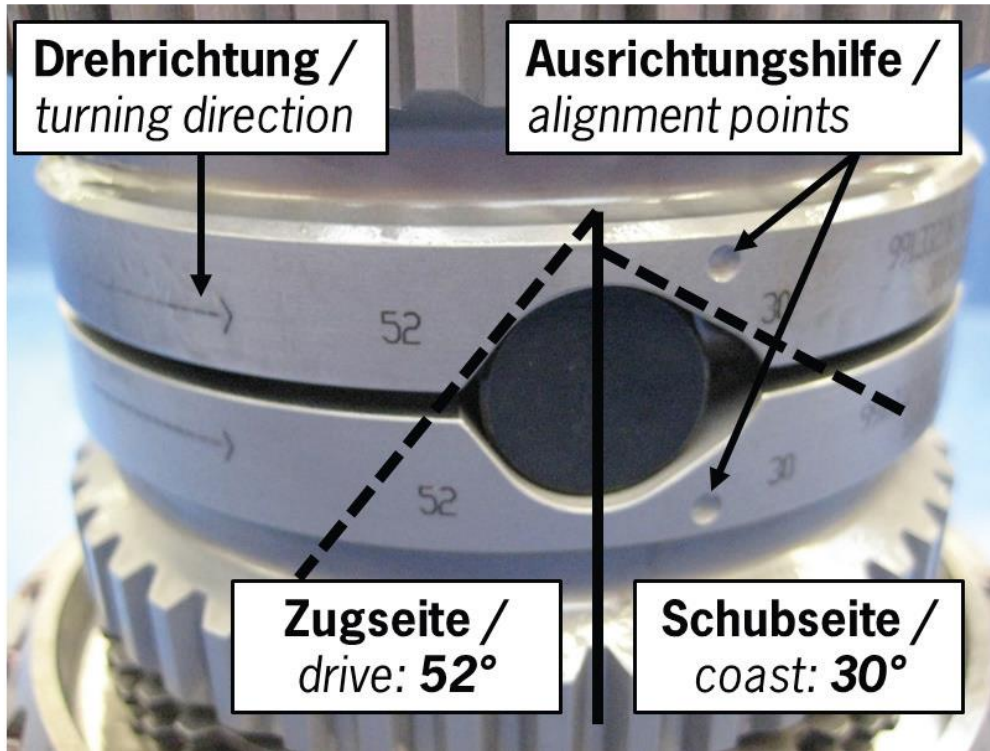

## ATTACHMENT G EXHAUST SYSTEMS



Exhaust System Nr 1 'Supercup' system

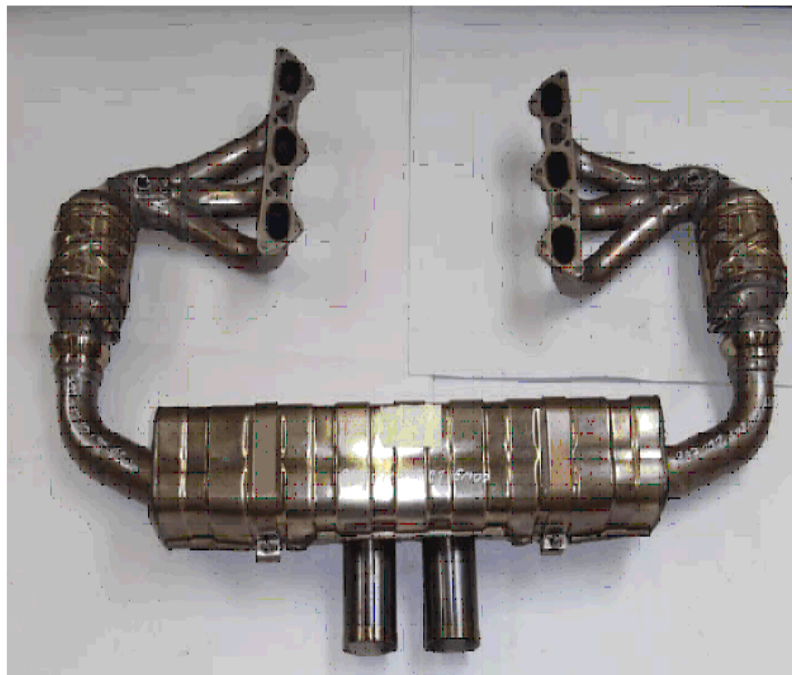

Exhaust System Nr 2 with centre rear muffler and attachments

**ATTACHMENT H**  
**REQUEST FOR REPAIRS**

**Engine and Gearbox units must be returned to Porsche Cars Australia for repair.**

**Attention:** Technical Manager  
 Porsche Carrera Cup Australia

Team Name	
Contact Name	
Contact Phone Number	
Return Fax Number	
Competition Number	
Chassis Number	WP0ZZZ99Z
Date	

Reason for repairs (Include component)

<b>Office Use Only</b>
Date Received: _____
Approval Nr: _____
Approval Date: _____
Signed: _____

**When completed please email to [motorsport@porsche.com.au](mailto:motorsport@porsche.com.au)**



## ATTACHMENT I

### DEFINITIONS

- CA:** The Category Administrator for the *Series* appointed by the *CM*
- CM:** The Category Manager for the *Series* appointed by *Motorsport Australia*
- CRSR:** Circuit Race Standing Regulations published by *Motorsport Australia*
- DRD:** The Deputy Race Director for the *Series* appointed by *Motorsport Australia*
- DSA:** The Driving Standards Advisor for the *Series* appointed by *Motorsport Australia*
- PCA:** Porsche Cars Australia Pty Ltd
- RD:** The Race Director for the *Series* appointed by *Motorsport Australia*
- RMC:** Race Management Channel
- Round:** A round of the *Series*
- Series:** The 2023 Porsche Michelin Sprint Challenge Australia Series
- TA:** The Technical Advisor for the *Series* appointed by the *CM*
- TD:** The Technical Delegate for the *Series* appointed by *Motorsport Australia*