

Sporting and Technical Regulations



PORSCHE
PAYNTER DIXON
CARRERA CUP
AUSTRALIA

TITLE PARTNER
**paynter
dixon**



2023 Porsche Paynter Dixon Carrera Cup Australia Championship

Sporting and Technical Regulations



Version 1	Published 24/03/2023
-----------	----------------------



Motorsport Australia ABN: 55 069 045 665
275 Canterbury Rd, Canterbury VIC 3126
Phone: +61 3 9593 7777 Hotline: 1300 883 959
motorsport.org.au

2023 Porsche Paynter Dixon Carrera Cup Australia Championship Sporting & Technical Regulations

A capitalised and italicised word in this document is defined in the FIA International Sporting Code (*Code*), the National Competition Rules (*NCR*), including their Appendices or [Attachment M](#) of this document.

Any HEADING is for reference only and has no regulatory effect.

CONTENTS

S1	TITLE AND JURISDICTION	7
S1.1	Title	7
S1.2	Authority / Jurisdiction.....	7
S2	ADMINISTRATION	7
S2.1	Personnel	7
S2.2	Sporting Committee	8
S3	COMPETITOR ELIGIBILITY	8
S4	AUTOMOBILE ELIGIBILITY	8
S4.1	Replacement <i>Automobile, engine or gearbox</i>	8
S5	DRIVER ELIGIBILITY	8
S5.1	Licence Requirements	8
S5.2	<i>Driver</i> Classification.....	9
S5.3	Substitute <i>Driver</i>	9
S5.4	<i>Driver</i> Transfer	9
S5.5	Porsche Michelin Junior Program Australia	9
S6	CHAMPIONSHIP ROUNDS/ REGISTRATION	9
S7	CHAMPIONSHIP CALENDAR	9
S8	ROUND FORMAT	10
S8.1	<i>Round</i> Format.....	10
S8.2	Qualifying Format.....	10
S8.3	Variation to Timetable	10
S9	GRID DETERMINATION	10
S9.1	Grid Determination	10
S9.2	<i>Driver</i> Qualification	10
S10	START PROCEDURE	11
S11	AWARDS AND POINTSCORE	11
S11.1	Prizes and Trophies	11
S11.2	<i>Championship</i> Pointscore.....	11
S11.3	Endurance Cup	12
S12	SCRUTINEERING	13
S12.1	Onus on <i>Competitor</i>	13
S12.2	Scrutineering and Technical Checks	13
S12.3	Initial Scrutineering	14

S12.4	Subsequent Scrutineering	14
S12.5	Targeted Scrutineering	14
S13	EVENT OPERATIONS	14
S13.1	<i>Championship Registration and Entry</i>	14
S13.2	<i>Driver/Team Manager Briefings</i>	15
S13.3	<i>Parc Fermé</i>	15
S13.4	Practice.....	16
S13.5	Qualifying	16
S13.6	Paddock.....	17
S13.7	<i>Pit Lane</i>	17
S13.8	Removal of <i>Automobile</i> from the paddock	18
S13.9	Radio Communication to/from <i>Automobile</i>	18
S13.10	Race Management Channel (<i>RMC</i>)	18
S13.11	Lap Triggers	18
S13.12	Leaving the <i>Circuit</i> whilst under investigation	18
S14	TYRES	18
S14.1	Control Tyre	18
S14.2	Tyre Treatment	19
S14.3	Tyre Bank.....	19
S14.4	Tyre Allocation/Marking.....	20
S14.5	Replacement Tyre	21
S14.6	Table Previously nominated tyre usage	21
S15	FUEL.....	21
S15.1	Control Fuel.....	21
S15.2	Fuel Storage	21
S15.3	Fuel Sampling	22
S15.4	Fuel Handling	22
S16	AUTOMOBILE MARKINGS.....	22
S16.1	Advertising Conditions	22
S16.2	<i>Automobile</i> Markings and <i>Championship</i> Identification	23
S16.3	Competition Numbers.....	23
S17	DRIVER APPAREL	23
S17.1	Standard of Apparel	23
S17.2	Reserved Signage on Racing Overalls	23
S18	TESTING.....	24
S18.1	Testing Restrictions	24
S18.2	Pre testing Procedures	24
S18.3	Testing Limits	24
S19	RAIN LIGHT.....	24
S20	IN-CAR CAMERAS	24
S20.1	VBox Video HD2 Camera System	24
S20.2	TV Production Cameras.....	25
S21	GROUND CLEARANCE.....	25

S22 ON BOARD FIRE EXTINGUISHER	25
S23 TELEMETRY, DATA RECORDING SYSTEMS	25
S24 DRY TO WET PROCEDURE	25
S24.1 Prior to the <i>Automobiles</i> being called to the marshalling area	25
S24.2 Before the race <i>Start</i>	25
S24.3 During the race	26
S25 PASSENGER RIDES	26
S26 JUDICIAL	26
S26.1 Demerit Point System	26
S26.2 Exceeding <i>Track Limits</i>	27
S27 2023 PORSCHE PAYNTER DIXON CARRERA CUP AUSTRALIA CHAMPIONSHIP CODE OF GOOD CONDUCT	
27	
ATTACHMENT A.....	29
<i>Automobile Markings – Reserved Areas</i>	29
ATTACHMENT A.....	30
<i>Automobile Markings – PRO</i>	30
ATTACHMENT A.....	31
<i>Automobile Markings – PRO-AM</i>	31
ATTACHMENT A.....	32
<i>Automobile Markings – Michelin Junior</i>	32
ATTACHMENT B.....	33
Fuel Container	33
ATTACHMENT C.....	34
In Car Camera Reserved Signage	34
T1 PREAMBLE.....	35
T2 PRINCIPLES OF THE TECHNICAL REGULATIONS	35
T3 ELIGIBILITY	36
T3.1 Eligible <i>Automobiles</i>	36
T3.2 Examination for Eligibility.....	36
T4 AUTOMOBILE DIMENSIONS	37
T5 COCKPIT.....	37
T5.1 Safety Cage.....	37
T5.2 Windscreen	37
T5.3 <i>Seat</i>	37
T5.4 Safety Harness.....	38
T5.5 Driver Racing Net	38
T5.6 Driver Cooling System	38
T5.7 Drinking System	38
T5.8 In-Car Cameras.....	38
T5.9 Timing Transmitter	38
T5.10 Fire Extinguisher	38
T5.11 <i>Coachwork</i>	39
T5.12 Ventilation.....	39
T5.13 Air Intake Blanking	39

T5.14	Roof Hatch.....	39
T6	TRANSMISSION/DIFFERENTIAL.....	39
T7	ENGINE TYPE.....	39
T8	ENGINE AND TRANSMISSION REPAIRS.....	39
T8.1	Duty of Notification.....	39
T8.2	Repairs.....	40
T9	SEALS.....	40
T10	SUSPENSION.....	40
T10.1	Suspension.....	40
T10.2	Dampers and Springs.....	41
T10.3	Ground Clearance.....	41
T10.4	Anti-Roll Bars.....	42
T11	BRAKES.....	42
T12	TELEMETRY, DATA RECORDING SYSTEM AND ECU.....	42
T12.1	Telemetry.....	42
T12.2	Data Recording System.....	42
T12.3	ECU and Wiring Lomm.....	43
T13	WHEELS.....	43
T14	AUTOMOBILE WEIGHT.....	43
T14.1	Minimum Weights.....	43
T14.2	Ballast.....	44
T14.3	Weighing Process.....	44
T15	LUBRICANTS.....	45
T15.1	Engine.....	45
T15.2	Transmission.....	45
T15.3	Oil Samples.....	45
T16	AERODYNAMIC DEVICES.....	45
T17	EXHAUST SYSTEM.....	45
T18	COOLING SYSTEM.....	46
ATTACHMENT D	47
	General Description of Automobile Components.....	47
ATTACHMENT E	51
	Recognition Document.....	51
ATTACHMENT F	55
	Request for Repairs.....	55
ATTACHMENT G	56
	Ride Height Measuring Points.....	56
ATTACHMENT H	57
	Exhaust System.....	57
ATTACHMENT I	58
	Ballast Mounting Points Position.....	58
ATTACHMENT J	59
	Transmission/Differential Ramp Angles.....	59
ATTACHMENT K	60

Seat Padding60

ATTACHMENT L 61

Alternative Part Number Reference Table61

ATTACHMENT M 62

Definitions62

2023 Porsche Paynter Dixon Carrera Cup Australia Championship Sporting Regulations

S1 TITLE AND JURISDICTION

S1.1 Title

This *Championship* will only be known as and referred to as the 2023 Porsche Paynter Dixon Carrera Cup Australia Championship.

S1.2 Authority / Jurisdiction

1.2.1 Each *Round* of the 2023 Porsche Paynter Dixon Carrera Cup Australia Championship (*Championship*) is to be held under the FIA International Sporting Code (*Code*) including Appendices; the *Motorsport Australia* National Competition Rules (*NCR*) and Circuit Race Standing Regulations (*CRSR*); the Sporting and Technical Regulations issued for this *Championship* by *Motorsport Australia*; *Supplementary Regulations* issued by the *Organiser*; Bulletins issued by the Stewards and any Driver Briefing Notes and instructions issued by the Race Director or the Clerk of the Course at an *Event*.

Note: Where any aspect of the Sporting Regulations must be adapted for a specific *Round*, this will be included in the *Supplementary Regulations* for that *Event* and/or a Bulletin at that *Event* and will take precedence over the Sporting Regulations.

1.2.2 This *Championship* has been sanctioned by *Motorsport Australia* as a National Championship.

1.2.3 Porsche Cars Australia Pty Ltd (*PCA*) has been appointed as the Category Manager (*CM*) by *Motorsport Australia* for this *Championship*.

Contact Details: Porsche Cars Australia Pty Ltd (ABN 67 004 327 048)

Barry Hay

109-111 Victoria Parade

Collingwood VIC 3066

Tel: (03) 9473 0941

Fax: (03) 9415 7906

S2 ADMINISTRATION

S2.1 Personnel

2.1.1 The following personnel have been appointed to the *Championship* by *Motorsport Australia* and/or the *CM* and have the authority to administer the various aspects of these regulations as detailed in the *CRSR*:

Race Director (<i>RD</i>)	David Stuart
Deputy Race Director (<i>DRD</i>)	Krystian Jackson
Technical Delegate (<i>TD</i>)	Stacey Paynter
Technical Advisor (<i>TA</i>)	Jesse Hammond

Driving Standards Advisor (DSA)	Karl Reindler
Category Administrator (CA)	Barry Hay
Category Operations (CO)	Kristy Brockway

S2.2 Sporting Committee

- 2.2.1 A Sporting Committee will be established comprising the following or their nominated representative:
- 2.2.1.1 Category Administrator
 - 2.2.1.2 Race Director
 - 2.2.1.3 Technical Advisor
- 2.2.2 The role of the Sporting Committee will be to resolve any issue regarding interpretation or application of the *Championship* Sporting and Technical Regulations including:
- 2.2.2.1 Queries concerning points or the classification of the Championship; and
 - 2.2.2.2 regulations that require amendment.
- 2.2.3 Decisions taken by the Sporting Committee will be final and not subject to protest or appeal.

S3 COMPETITOR ELIGIBILITY

To be eligible to compete in the *Championship*, each *Competitor* must hold a current Motorsport Australia Competitor Licence and be a party to a current Participation Agreement with the *CM*.

S4 AUTOMOBILE ELIGIBILITY

Each *Automobile* must comply with the requirements of the 2023 Porsche Paynter Dixon Carrera Cup Australia Championship Technical Regulations to be eligible to compete in the *Championship*. Each *Automobile* must be registered with the *CM* and must be the subject of a current Race Vehicle Authorisation Certificate (RVAC) issued by *PCA*.

S4.1 Replacement *Automobile*, engine or gearbox

- 4.1.1 Following the commencement of the first practice session of each *Round*, any *Automobile* that has been entered to compete at that *Round* may not be replaced with another *Automobile*.
- 4.1.2 Any change of an *Automobile*'s engine and/or gearbox during a *Round* or between *Rounds* must be approved in advance by the *TA*.

S5 DRIVER ELIGIBILITY

S5.1 Licence Requirements

- 5.1.1 To be eligible to compete in the *Championship*, a *Driver* must:
 - 5.1.1.1 be a minimum of 17 years of age; and
 - 5.1.1.2 hold a current Motorsport Australia Circuit Licence without Provisional endorsement or higher; and
 - 5.1.1.3 pass an online test to the satisfaction of the *CM*.
- 5.1.2 Each *Driver's Licence* will be verified at each *Round* and participation will be denied if a *Licence* and any associated requirement is not valid.

S5.2 Driver Classification

5.2.1 Each *Driver* will be assessed by the *CM* prior to entering the *Championship* and will be deemed to be one of the following classifications for the purpose of awarding class points:

5.2.1.1 Pro

5.2.1.2 Pro-Am

5.2.2 Each *Driver* will be advised in writing by the *CM* of their classification.

5.2.3 A *Driver's* classification may be changed at any time as determined and advised by the *CM*.

S5.3 Substitute Driver

Prior to the commencement of the first qualifying session at each *Round*, a *Competitor* may nominate a substitute *Driver* who may be permitted to compete in the remainder of the *Event* subject to the approval of the Stewards and the *CM*.

S5.4 Driver Transfer

A *Driver* may transfer from one *Competitor* to another and/or change *Automobile* (chassis/VIN#) during the *Championship* but must first submit their intention in writing to the *CM*. Such *Driver* must comply with the requirements of Article S14.1.4 regarding tyre bank.

S5.5 Porsche Michelin Junior Program Australia

A *Driver* recognised by the *CM* as part of the Porsche Michelin Junior Program Australia must abide by the conditions of the agreement to be part of this program.

S6 CHAMPIONSHIP ROUNDS / REGISTRATION

6.1 The *Championship* will be conducted over 8 *Rounds* as detailed in the *Championship* Calendar below.

6.2 Each race conducted as a part of the *Championship* will count in determining the final results.

6.3 Each *Competitor* is required to be registered with the *CM* prior to competing in the *Championship*.

S7 CHAMPIONSHIP CALENDAR

The *Championship* will be conducted over the following *Rounds*:

Round	Date	Circuit	Qualifying Format
1	30 March – 2 April	Albert Park	1
2	16 – 18 June	Hidden Valley	2
3 ^{^^}	7 – 9 July	Reid Park, Townsville	2
4 ^{^^}	18 – 20 August	The Bend Motorsport Park	1
5 ^{^^}	15 – 17 September	Sandown	2
6 ^{^^}	5 – 8 October	Mount Panorama	1
7 ^{^^}	27 – 29 October	Surfers Paradise	2
8 ^{^^}	23 – 26 November	Adelaide Parklands	2

^{^^} Denotes a *Round* which includes races counting towards the Endurance Cup.

Note: The above calendar is subject to change. The *CM* will advise each *Competitor* of any change.

Any decision to change the *Championship* calendar and/or associated races will not be subject to any claim for damages or performance.

S8 ROUND FORMAT

The number, length and format of *Track* sessions will ultimately be negotiated between the *CM* and the *Organiser* prior to a *Round* and will be advised in the *Supplementary Regulations* issued for an *Event*.

Generally, the format for each *Round* will be as follows:

S8.1 Round Format

- 8.1.1 Practice: A minimum of 40 minutes of practice time.
- 8.1.2 Qualifying: Refer S8.2 and [Table S7](#).
- 8.1.3 Races: A minimum of 70 minutes of race time will be scheduled at each *Round* as detailed in the *Supplementary Regulations*. Each race is to be expressed as a number of laps.

S8.2 Qualifying Format

- 8.2.1 Qualifying Format 1: 1 x 20 minute qualifying session for Pro and Pro-Am Class *Automobiles*.
- 8.2.2 Qualifying Format 2: 1 x 12 minute qualifying session for Pro Class *Automobiles*; plus
1 x 12 minute qualifying session for Pro-Am Class *Automobiles*.

S8.3 Variation to Timetable

- 8.3.1 The timetable may be varied at any time due to exceptional circumstances only with the approval of the Stewards.
- 8.3.2 If a race is cancelled due to *Force Majeure* or safety reasons, the *CM* is under no obligation to reschedule that race.

S9 GRID DETERMINATION

S9.1 Grid Determination

- 9.1.1 The grid for each race will be made up of both Pro and Pro-Am Class *Automobiles*.
- 9.1.2 The grid for the first race at each *Round* will be determined as follows:
 - 9.1.2.1 the Pro Class *Automobile* with the fastest qualifying lap time on grid position 1; followed by
 - 9.1.2.2 the remainder of the Pro Class *Automobiles* in order of fastest qualifying lap time; followed by
 - 9.1.2.3 the Pro-Am Class *Automobile* with the fastest qualifying lap time on the first available grid position after the last Pro Class *Automobile*; followed by
 - 9.1.2.4 the remainder of the Pro-Am Class *Automobiles* in order of fastest qualifying lap time.
- 9.1.3 The grid for each subsequent race at that *Round* will be determined as detailed in the *CRSR* except that all Pro Class *Automobiles* will be gridded in front of the Pro-Am Class *Automobiles*.
- 9.1.4 A rear of grid penalty will place the *Automobile* at the rear of the grid for the Class of that *Automobile*.

S9.2 Driver Qualification

Any *Driver* whose best lap time achieved in a qualifying session exceeds 109% of the fastest lap time achieved by an *Automobile* in their Class in that session will be prohibited to further compete at that *Round* unless approved otherwise by the Stewards due to exceptional circumstances.

S10 START PROCEDURE

- 10.1 Unless otherwise stated in the *Supplementary Regulations*, the *Start* procedure for each race will be as detailed in the *CRSR – Non-Championship Start – Standing Start* except that, where approved by *Motorsport Australia*, the formation lap may be greater than one lap of the *Track*.
- 10.2 Any *Automobile* unable to leave the marshalling area for the formation lap with the rest of the field will only be permitted to proceed at the discretion of the *RD*.

S11 AWARDS AND POINTSCORE

S11.1 Prizes and Trophies

- 11.1.1 Prizes, trophies and awards will be as determined by the *CM* and will be advised to each *Competitor*.
- 11.1.2 A minimum of 5 *Rounds* must be conducted for a winner of the *Championship*, each *Class* and the *Endurance Cup* to be declared.
- 11.1.3 The winner of the *Championship* must be present at the annual *Motorsport Australia National Awards Prize Giving Ceremony*. Failure to attend the ceremony by the winner will be deemed an infringement of these regulations unless prior agreement has been given by *Motorsport Australia*.

S11.2 Championship Pointscore

- 11.2.1 Unless otherwise detailed in the *Supplementary Regulations*, points will be awarded to *Drivers* for each race in the *Championship*, subject to the number of races scheduled for that *Round*, as follows:

Finish position	Points			Finish position	Points		
	Rounds with 2 races	Rounds with 3 races	Rounds with 4 races		Rounds with 2 races	Rounds with 3 races	Rounds with 4 races
1 st	90	60	45	15 th	17	11	9
2 nd	81	54	41	16 th	15	10	8
3 rd	72	48	36	17 th	14	9	7
4 th	63	42	32	18 th	12	8	6
5 th	54	36	27	19 th	10	7	5
6 th	48	32	24	20 th	9	6	4
7 th	44	29	22	21 st	7	5	3
8 th	39	26	20	22 nd	6	4	2
9 th	34	23	17	23 rd	4	3	1
10 th	30	20	15	24 th	3	2	1
11 th	27	18	14	25 th	1	1	1
12 th	24	16	12	26 th	1	1	1
13 th	21	14	11	27 th	1	1	1
14 th	18	12	10	28 th	1	1	1

- 11.2.2 In addition to the above, 1 point will be awarded to each *Driver* awarded pole position in their *Class* in the *Final Classification for Qualifying*. This point will be added to the *Round* points.
- 11.2.3 Points will only be awarded to the *Drivers* classified as finishers in the final results of each race.
- 11.2.4 Points will be awarded for the following *Classes*:
- 11.2.4.1 Pro
- 11.2.4.2 Pro-Am

- 11.2.5 Each *Driver* in the Pro Class who is classified as a finisher in a race will be awarded Pro Class points in accordance with the [Table S11.2](#) relative to each other *Driver* who is classified as a finisher in the Pro Class in that race.
- 11.2.6 The *Driver* who accumulates the greatest number of Pro Class points over the total number of *Rounds* that are conducted (subject to Article S11.1.2, S11.2.9 and S11.2.10) will be declared the 2023 Porsche Paynter Dixon Carrera Cup Australia Pro Champion.
- 11.2.7 Each *Driver* in the Pro-Am Class who is classified as a finisher in a race will be awarded Pro-Am Class points in accordance with [Table S11.2](#) relative to each other *Driver* who is classified as a finisher in the Pro-Am Class in that race.
- 11.2.8 The *Driver* who accumulates the greatest number of Pro-Am Class points over the total number of *Rounds* that are conducted (subject to Article S11.1.2, S11.2.9 and S11.2.10) will be declared the 2023 Porsche Paynter Dixon Carrera Cup Australia Pro-Am Champion.
- 11.2.9 In addition to Articles S11.2.6 and S11.2.8, if the maximum number of *Automobiles* permitted by the Track Licence for a *Circuit* is less than the number of entries received for that *Round* and the entry of a *Competitor* who has paid for full Championship entry is unable to be accepted, the lowest point scoring *Round* for each *Driver* in that Class will not be considered in the number of points accumulated for that Class of the *Championship*.
- 11.2.10 In addition to Articles S11.2.6 and S11.2.8, if a *Driver* is unable to attend a *Round* solely due to Government restrictions imposed because of a pandemic, the *CM* will have the discretion to alter the number of *Rounds* that may be used to accumulate points for each *Driver* in that Class to determine the winner of the Class, e.g. if 7 *Rounds* have been conducted, only each *Driver's* 6 highest scoring *Rounds* may be used. Each *Round* where this occurs will be considered separately by the *CM* and any decision will be advised to each *Competitor* by the *CM*. Any decision of the *CM* in this regard will not be subject to protest or appeal.
- 11.2.11 The results for each Class at a *Round* will be determined by the number of points scored by each *Driver* at that *Round*. In the event of a tie at the end of any *Round*, the final positions for that *Round* will be determined by comparing the results of each of the tied *Drivers* in the final race of that *Round*. The higher place in the *Round* results will be awarded to the *Driver* with the higher finishing position in the final race.
- 11.2.12 In the event of a tie at the end of the *Championship* in any Class, final positions will be determined by comparing the race results achieved by each tied *Driver* in the *Rounds* they used to accumulate points for the *Championship*, with the *Driver* with the highest number of first places being awarded the higher *Championship* position. If a tie still exists, it will be resolved by comparing the number of second, third or fourth places (and so on) achieved by each tied *Driver* until all positions have been determined.

S11.3 Endurance Cup

- 11.3.1 Subject to calendar changes, the Endurance Cup will consist of 6 x 40/45-minute races across 6 *Rounds* as outlined in [Table S7](#).
- 11.3.2 Points will be awarded for the following Classes in accordance with [Table S11.2](#):
- 11.3.2.1 Pro
- 11.3.2.2 Pro-Am
- 11.3.3 Points will only be awarded to *Drivers* classified as finishers in the final results of each Endurance Cup race.

- 11.3.5 The Pro Class *Driver* who accumulates the greatest number of points over the total number of Endurance Cup races that are conducted (subject to Article S11.1.2 and S11.3.6) will be the winner of the Endurance Cup Pro Class.
- 11.3.6 The Pro-Am Class *Driver* who accumulates the greatest number of points over the total number of Endurance Cup races that are conducted (subject to Article S11.1.2 and S11.3.6) will be the winner of the Endurance Cup Pro-Am Class.
- 11.3.7 In addition to Articles S11.3.4 and S11.3.5, if the maximum number of *Automobiles* permitted by the Track Licence for a *Circuit* is less than the number of entries received for that *Round* and the entry of a *Competitor* who has paid for full Championship entry is unable to be accepted, the lowest point scoring *Round* for each *Driver* in that Class will not be considered in the number of points accumulated for that Class of the Endurance Cup.
- 11.3.8 In addition to Articles S11.3.4 and S11.3.5, if a *Driver* is unable to attend a *Round* that has an Endurance Cup race solely due to Government restrictions imposed because of a pandemic, the *CM* will have the discretion to alter the number of races that may be used to accumulate points for each *Driver* in that Class to determine the winner of the Class, e.g. if 6 races have been conducted, only each *Driver*'s 5 highest scoring races may be used. Each *Round* where this occurs will be considered separately by the *CM* and any decision will be advised to each *Competitor* by the *CM*. Any decision of the *CM* in this regard will not be subject to protest or appeal.
- 11.3.9 In the event of a tie at the end of the Endurance Cup in any Class, final positions will be determined by comparing the Endurance Cup race results achieved by each tied *Driver*, the *Driver* with the highest number of first places in their Class being awarded the higher Endurance Cup position in that Class. If a tie still exists, it will be resolved by comparing the number of second, third or fourth places in Class (and so on) achieved by each tied *Driver* until all positions have been determined. If at this stage a tie still exists, the higher position will be awarded to the *Driver* with the higher finishing position in the final Endurance Cup race.

S12 SCRUTINEERING

S12.1 Onus on *Competitor*

- 12.1.1 The onus is on the *Competitor*, or their nominated representative, to present their *Automobile* for scrutineering at the appropriate times, in a complete and finished state, in 'ready to race' condition including each marking and *Seal* on the *Automobile* in accordance with the Sporting Regulations and Technical Appendix, Schedule K of the *Manual* and an operating timing transmitter in position on the *Automobile*.
- 12.1.2 The presentation by the *Competitor* of their *Automobile* for scrutineering will be deemed an implicit statement of conformity with the *Rules*.

S12.2 Scrutineering and Technical Checks

- 12.2.1 Before and, as required, during or after each *Competition*, each *Automobile* will be inspected by the *TD* or their nominee. Any *Automobile* or part of an *Automobile* can be selected at any time by the *TD* or if requested, by the Stewards for a further examination, including examination outside of the *Event*.
- 12.2.2 The *TD* or their nominee is entitled to check any aspect of an *Automobile* at any time during an *Event* without question or an explanation.
- 12.2.3 Each *Competitor* and *Driver* must at all times follow any instruction of the *TD* or their nominee regarding the checking and re-inspection of their *Automobile*.

12.2.4 *Automobile* and *Drivers'* safety equipment must be shown to the *TD* or their nominee for technical and visual examination during the stated inspection period/s.

12.2.5 Any *Automobile* provided with permission to leave the paddock (refer Article S13.7) must be presented again to the *TD* before taking any further part in the *Competition*. It is the *Competitor's* responsibility to present the *Automobile* to the *TD*.

S12.3 Initial Scrutineering

12.3.1 Each *Automobile* must be checked and approved for *Competition* by the *TD* or their nominee prior to the first *Track* session at each *Round*.

12.3.2 Any non-compliance identified by the *TD* or their nominee may result in a request for further checks at a nominated time. Failure by the *Competitor* to meet this requirement may result in the *Automobile* being prohibited access to any *Track* session.

12.3.3 The following documents must be presented at Initial Scrutineering:

12.3.3.1 *Automobile* log book

12.3.3.2 Safety Cage Certificate (if requested)

S12.4 Subsequent Scrutineering

12.4.1 After each qualifying session and race, each *Automobile* must be brought to the *Parc Fermé*, by the route described in the Driver Briefing, by the *Driver* in full racing equipment.

12.4.2 Each *Automobile* is subject to *Parc Fermé* conditions until released by the *TD* or the Stewards or when the green flag replaces the red flag in front of the technical area. During this time, the only work permitted to be performed on an *Automobile* is recording the tyre pressures and opening the rear bonnet lid.

12.4.3 Once in *Parc Fermé*, it is prohibited to remove an *Automobile* without the permission of the *TD* or their nominee.

12.4.4 If *Automobiles* are placed in *Parc Fermé* conditions in the paddock marquee, all personnel must vacate the marquee immediately until *Parc Fermé* concludes unless otherwise instructed by the *TD* or their nominee.

12.4.5 An *Automobile* that has been involved in an incident at any time during an *Event* must be presented to the *TD* or their nominee. Any repairs identified by the *TD* must be undertaken by the *Competitor* and the *Automobile* re-presented to the *TD*. It is the *Competitor's* responsibility to do so before taking part in the *Competition* again.

12.4.6 Any *Automobile* that is permitted to leave the paddock for repairs after an incident must be presented again to the *TD* before taking any further part in the *Competition*. It is the *Competitor's* responsibility to present the *Automobile* to the *TD*.

S12.5 Targeted Scrutineering

Scrutineering at each *Round* will be conducted according to the Targeted Scrutineering Procedures published by *Motorsport Australia*.

S13 EVENT OPERATIONS

S13.1 Championship Registration and Entry

13.1.1 The *Championship* will operate under the Motorsport Australia Series Registration and Entry Process. Registration and Entry Forms will be available from the *CM* with document checking being conducted by the *CM* prior to the first official *Track* session at each *Round*.

- 13.1.2 Subject to the maximum number of *Automobiles* permitted by the Track Licence for the *Circuit* at each *Round*, a maximum of 36 entries will be accepted for each *Round*.
- 13.1.3 If the number of entries is greater than the maximum number of *Automobiles* permitted by the Track Licence for the *Circuit* at a *Round*, entries will be accepted in order of:
- 13.1.3.1 *Drivers* who have paid the full entry fee for all 8 *Rounds* of the *Championship* by 23 February 2023; then
- 13.1.3.2 the number of Porsche Carrera Cup Australia races each *Driver* has completed since 2003; then
- 13.1.3.3 *Automobile* model year 2022; then
- 13.1.3.4 *Automobile* model year 2023.
- 13.1.4 The *CM* reserves the right to refuse the *Entry* of a *Competitor* and/or *Driver* at their discretion having stated the reason. There is no automatic entitlement or acceptance of participation in the *Championship*.

S13.2 Driver/Team Manager Briefings

- 13.2.1 At each *Round*, each *Driver* and Team Manager (i.e. an appropriately authorised representative of the *Competitor*, other than the *Driver*) must attend the compulsory *Driver* Briefing for its full duration.
- 13.2.2 The time and location of the *Driver* briefing will be detailed in the *Supplementary Regulations* for the *Event* and any Team Manager meeting in the Team Notes provided by the *CM*.
- 13.2.3 The attendance sheet must be signed by the *Driver* and the Team Manager to confirm attendance.
- 13.2.4 Other compulsory briefings may be convened as required and will be advised to each *Competitor* accordingly.
- 13.2.5 If a *Driver* or Team Manager is unable to attend a briefing due to exceptional circumstances, they must notify the *RD* no less than 60 minutes prior to the commencement of the briefing.
- 13.2.6 A *Driver* will be prohibited to participate at a *Round* until they have attended any Driver/Team Manager briefing or, where agreed by exception, received a personal briefing from the *RD*.
- 13.2.7 Use of a mobile phone by any person at a briefing will be deemed as non-attendance of that person at that briefing.
- 13.2.8 Non-attendance for any part of a briefing will be subject to imposition of a penalty by the Stewards in accordance with the *CRSR*.

S13.3 Parc Fermé

- 13.3.1 Unless otherwise advised by the *CM*, the location of *Parc Fermé* for each *Round* will be in front of the *Automobile's* garage..
- 13.3.2 The *TD* or their nominee is responsible for the operation of *Parc Fermé* and are the only officials authorised to provide instructions in this respect to a *Competitor*.
- 13.3.3 Each *Automobile*, including those remaining in *Pit Lane*, must proceed directly to the designated *Parc Fermé* area via the most direct route (or as directed by Officials) at the conclusion of qualifying without interference from any third party (other than an Official).
- 13.3.4 Each *Automobile* completing each race must proceed directly to the designated *Parc Fermé* area via the most direct route (or as directed by Officials) at the conclusion of the race and without interference from any third party (other than an Official).
- 13.3.5 Any *Automobile* required for a podium presentation will be under *Parc Fermé* conditions and may be driven to the designated *Parc Fermé* area by a team member.

- 13.3.6 If an *Automobile* cannot proceed to the designated *Parc Fermé* area under its own power, a team member must advise the *TD* or their nominee as soon as practicable and receive further instruction.
- 13.3.7 Unless granted permission by the *CM*, the *Driver* of each *Automobile* in *Parc Fermé* must remain in the *Championship* paddock.
- 13.3.8 1 team member per *Automobile* may be permitted to enter the designated *Parc Fermé* area for the purpose of checking tyre pressures only. This will be permitted at the direction of the *TD* or their nominee only and the team member must leave the *Parc Fermé* area immediately once the tyre pressure check is completed.
- 13.3.9 An *Automobile* may not be removed from any *Parc Fermé* except at the direction of the *TD* or their nominee.

S13.4 Practice

- 13.4.1 The order in which each *Automobile* proceeds onto the *Track* for the first practice session at *Round 1* will be determined by the previous year's final outright point score followed by any new *Drivers* to the *Championship* in the *Automobile's* competition number order with all Pro Class *Automobiles* preceding any Pro-Am Class *Automobile*.
- 13.4.2 The order in which each *Automobile* proceeds onto the *Track* for the first practice session from *Round 2* onwards will be determined by the Pro and Pro-Am *Championship* point score order at the conclusion of the previous *Round* with all Pro Class *Automobiles* preceding any Pro-Am Class *Automobile*.
- 13.4.3 The order in which each *Automobile* proceeds onto the *Track* for the second and subsequent practice sessions at a *Round* will be determined by the fastest lap times achieved from the previous Practice session with the *Automobile* that achieves the fastest lap time proceeding onto the *Track* first and so on with all Pro Class *Automobiles* preceding any Pro-Am Class *Automobile*.
- 13.4.4 If an *Automobile* is unable to proceed onto the *Track* in the order specified above, the *CM* may indicate to the next *Automobile* to take its place in the order.
- 13.4.5 If an *Automobile* is unable to proceed onto the *Track* at the commencement of a session, the *RD* will determine whether it can take part in that session.
- 13.4.6 During each practice session each *Automobile* must park nose in at an angle of approximately 45 degrees in their allocated *Pit Bay* when in *Pit Lane*. When leaving its *Pit Bay*, the *Automobile* must be pushed backwards (not reversed under its own power) with a team member ensuring it is released safely and without impeding any other *Automobile*.
- 13.4.7 If a red flag is displayed during a practice session, each *Automobile* must return to its allocated *Pit Bay* and remain there until the exit of the *Pit Lane* is open to recommence the session or advised otherwise on *RMC* by the *RD*.
- 13.4.8 Any *Automobile* that enters the *Pit Lane* or is still in the *Fast Lane* after the chequered flag is displayed must remain in the *Fast Lane* and proceed to the *Parc Fermé* or as otherwise directed by an official.

S13.5 Qualifying

- 13.5.1 The order in which each *Automobile* proceeds onto the *Track* at the commencement of each qualifying session will be determined by the fastest lap times achieved in the combined practice sessions at that *Round* with the *Automobile* which achieved the fastest lap time proceeding onto the *Track* first and so on with all Pro Class *Automobiles* preceding any Pro-Am Class *Automobile*. If 2 or more *Automobiles* achieved the same fastest lap time in practice, the order will be the *Automobile* that first set the lap time first and so on.
- 13.5.2 If results from practice are unavailable, the order in which each *Automobile* proceeds onto the *Track* will be the order of the results of the previous *Championship* race.

- 13.5.3 If an *Automobile* is unable to proceed onto the *Track* in the order specified above, the *CM* may indicate to the next *Automobile* to take its place in the order.
- 13.5.4 If an *Automobile* is unable to proceed onto the *Track* at the commencement of a session, the *RD* will determine whether it can take part in that session
- 13.5.5 During each qualifying session each *Automobile* must park nose in at an angle of approximately 45 degrees in their allocated *Pit Bay* when in *Pit Lane*. When leaving its *Pit Bay*, the *Automobile* must be pushed backwards (not reversed under its own power) with a team member ensuring it is released safely and without impeding any other *Automobile*.
- 13.5.6 During qualifying an *Automobile* may not return to the paddock/garage area without the permission of the *TD*. If an *Automobile* exits *Pit Lane* to the paddock/garage during qualifying it will not be permitted to re-join that session.
- 13.5.7 Any *Driver* that causes a red flag to be displayed during a qualifying session will have their fastest lap time for that session at the time that red flag was displayed deleted. The *Driver* that caused the red flag to be displayed may continue if the session recommences.
- 13.5.8 If a red flag is displayed during a qualifying session, each *Automobile* must return to its allocated pit bay and remain there until the exit of the *Pit Lane* is open to recommence the session or advised otherwise on *RMC* by the *RD*.
- 13.5.9 If a qualifying session is stopped by display of the red flag and not resumed, from the time that the *RD* announces on *RMC* that the session will not be resumed it is prohibited to work on an *Automobile* and each *Automobile* will be in *Parc Fermé* conditions.
- 13.5.10 Unless authorised by the *TD*, it is prohibited to work on an *Automobile* in the *Pit Lane* once the chequered flag has been displayed at the conclusion of a qualifying session.
- 13.5.11 Any *Automobile* that enters the *Pit Lane* or is still in the *Fast Lane* after the chequered flag is displayed must remain in the *Fast Lane* and proceed to the *Parc Fermé* or as otherwise directed by an official. Any work, including taking tyre pressures, is prohibited until the *Automobile* is in the *Parc Fermé*.

S13.6 Paddock

- 13.6.1 Each *Competitor* with 3 *Automobiles* will be permitted 1 transporter. If a *Competitor* has a less than 3 *Automobiles* an application for a transporter must be made to the *CM*. No additional transporter or other vehicle which would require parking space in the paddock will be permitted access to the *Event* unless permission has been granted by the *CM*.
- 13.6.2 Each *Competitor* must ensure that:
 - 13.6.2.1 any safety relevant aspect of its team's working processes are fulfilled and observed;
 - 13.6.2.2 their *Automobile's* garage area is clean and tidy;
 - 13.6.2.3 any hazardous liquid (any liquid other than water) is collected in a suitable container or absorbing sheet and disposed of in the designated area.
- 13.6.3 Except when unloading or loading an *Automobile* at the beginning or end of an *Event*, or given permission during the *Event* by the *CM*, the tailgate on a transporter must remain closed.
- 13.6.4 Any person working on the setup or dismantling of the paddock area must wear high visibility clothing.

S13.7 Pit Lane

- 13.7.1 Each Pit Crew member is required to sign a Pit Lane Indemnity Form prior to the first *Track* session and to display identification as and if required by the *Organiser*.

- 13.7.2 Each *Competitor* is responsible for the conduct of their *Driver*, team members and guests and must ensure that they are wearing the correct credential in the *Pit Lane*.
- 13.7.3 The *CM* will allocate a working area for each *Automobile* in the *Working Lane* of the *Pit Lane* which will be advised to each *Competitor*. Unless advised otherwise by the *TD* or their nominee, this is the only area in which work may be carried out on that *Automobile* when in the *Pit Lane*.
- 13.7.4 The *Fast Lane* must be kept clear of any obstruction and it is each *Competitor's* responsibility to ensure that their *Automobile*, pit crew and equipment do not encroach on the *Fast Lane*.
- 13.7.5 Any equipment in *Pit Lane* associated with an *Automobile* must be kept as close as possible to the pit garage.
- 13.7.6 The *Driver* must activate the Pit Lane Speed Limiter while their *Automobile* is moving in the *Pit Lane*.

S13.8 Removal of *Automobile* from the paddock

- 13.8.1 When initial scrutineering of an *Automobile* is complete, it is prohibited to remove that *Automobile* from the paddock (other than to go on *Track*) prior to the release of all *Automobiles* from the *Parc Fermé* established following the final race of that *Round* without the prior written approval of the *TD*.
- 13.8.2 Unless stated otherwise in the *Driver Briefing*, it is prohibited to drive an *Automobile* on a public road during a *Round*.

S13.9 Radio Communication to/from *Automobile*

Two way radio communications between the *Driver* and a member of the pit crew is mandatory at all times whilst the *Automobile* is on the *Track*.

S13.10 Race Management Channel (*RMC*)

- 13.10.1 A minimum of 1 senior team member for each competing *Automobile* must monitor *RMC* at all times during practice, qualifying or racing.
- 13.10.2 This team member must monitor *RMC* from the time that the marshalling of *Automobiles* commences prior to their release from the pit/paddock bay until all *Automobiles* have returned to their allocated pit/paddock bay at the conclusion of *Parc Fermé* following any practice, qualifying or race.
- 13.10.3 All relevant messages received on the *RMC* must be relayed to the *Driver*.
- 13.10.4 Details of the *RMC* frequency will be available from the *CM*.

S13.11 Lap Triggers

The use of individual beacons is prohibited.

S13.12 Leaving the *Circuit* whilst under investigation

If a *Competitor* or *Driver* leaves the *Circuit* without the permission of the *RD* whilst under investigation, any penalty imposed by the Stewards as a result of that investigation will be binding and not subject to appeal.

S14 TYRES

S14.1 Control Tyre

- 14.1.1 Only the control tyres listed below, complete with barcode identification, are permitted for use in each *Round* of the *Championship*:

	Dry Weather tyres	Wet Weather tyres
Front	Michelin Slick – Cup N3 Competition 30/65-18	Michelin Rain – P2L 30/65-18
Rear	Michelin Slick – Cup N3R Competition 31/71-18	Michelin Rain – P2L 31/71-18

14.1.2 Only tyres supplied by the following supplier may be used:

European Technique

338 Swan Street
Richmond VIC 3121
Ph: 03 9428 5547
Fax: 03 9428 0839

- 14.1.3 Except for the condition described in Article S14.1.4, each control tyre must only be allocated to a specific *Automobile*, identified by its *Chassis*/VIN number.
- 14.1.4 Unless otherwise approved by the *CM*, a *Driver* that changes *Automobile* or team during the *Championship* will maintain the tyre bank of their initial *Automobile*.
- 14.1.5 Unless authorised by the *TD*, each control tyre must only be mounted with the barcode facing outwards. The *TD* will only authorise a tyre to be “turned” on the rim if in agreement with Michelin they deem it is otherwise not useable.
- 14.1.6 If a barcode becomes illegible, the *Competitor* must immediately report it to the *TD* or their nominee who will then mark the tyre.
- 14.1.7 Any control tyre that is not fitted to the *Automobile* during powertrain warmup must be placed at the front of the garage/marquee or behind the teams walling.
- 14.1.8 It is recommended that each *Competitor* follows the recommendations and instructions of Michelin regarding tyre pressure and setup.

S14.2 Tyre Treatment

- 14.2.1 A section of “build up” measuring a maximum of 50 mm across the entire tread may be removed from each tyre to allow the tyre tread depth to be measured at a maximum of 2 locations on any 1 tyre.
- 14.2.2 It is prohibited to heat any tyre during a *Round*. This includes the use of any device (e.g. heated covers) or chemical treatment or any other form of tyre heating which artificially preserves or varies the temperature in or of a control tyre, regardless of whether the control tyre is mounted on a wheel or not. Further, it is prohibited to fit a front wheel and tyre to the rear axle of an *Automobile* during powertrain warm up. If fitted to the *Automobile*, each wheel and tyre must be fitted in its respective position only.
- 14.2.3 During a *Round*, the removal of rubber abrasion and stones from a tyre is permitted by mechanical means only. The use of a heat gun or similar device is prohibited.
- 14.2.4 From the time an *Automobile* is called to the marshalling area until the end of the corresponding *Track* session, it is prohibited to cover any approved tyre. This applies to both dry and wet weather tyres.

S14.3 Tyre Bank

- 14.3.1 The following tyres will be added to the Tyre Bank for an *Automobile* (identified by its *Chassis*/VIN number):
- 14.3.1.1 4 tyres from practice of the first *Round* that the *Automobile* enters (refer S4.4.4.11); and
- 14.3.1.2 any Joker tyre taken/used by the *Competitor* after practice; and
- 14.3.1.3 each tyre marked for use on the *Automobile* for qualifying and races.

14.3.2 Additionally, for the entire *Championship*, 16 (8 front and 8 rear) new tyres will be allocated to each *Automobile* of which up to 4 (2 front and 2 rear) may be used as Joker tyres during Practice only at each *Round*. The use of 1 or more Joker tyres must be announced to the *TD* prior to the commencement of Practice. If an *Automobile* does not participate at one or more *Rounds*, the total number of Joker tyres available for use at a future *Round* will be reduced by 2 (1 front and 1 rear) for each non-participation *Round*.

14.3.3 The maximum number of tyres to be added to the Tyre Bank for each *Automobile* at each *Round* is as per the table below:

Round	Practice	Qualifying and Races
1	16 Joker Tyres	8
2		8
3		8
4		8
5		8
6		8
7		8
8		8

S14.4 Tyre Allocation/Marking

14.4.1 Any reference to marking of tyres in these regulations includes the procedure of electronically scanning and recording the barcode of a tyre.

14.4.2 Each tyre must be presented for marking a minimum of 45 minutes prior to the start time of the practice and qualifying session. If presented after this time, it will be at the discretion of the *TD* to mark a tyre.

14.4.3 For practice:

14.4.3.1 For the first *Round* that an *Automobile* enters, a maximum of 8 (4 front and 4 rear) new or used dry weather tyres are permitted to be used. Only 4 (2 front and 2 rear) of these tyres will be added to the Tyre Bank allocated to that *Automobile*;

14.4.3.2 For each subsequent *Round*, the number of dry weather tyres is free but only dry weather tyres previously marked into the Tyre Bank are permitted to be used;

14.4.3.3 For use of Joker tyres refer to Article 14.3.2;

14.4.3.4 The number of wet weather tyres is free.

14.4.4 For qualifying and races:

14.4.4.1 Only the tyres marked for qualifying and each race at that *Round* are permitted to be used and are the only tyres permitted to be taken into *Pit Lane*;

14.4.4.2 A maximum of 8 tyres (4 front and 4 rear) may be marked for each *Automobile* at each *Round*. These tyres will be added to the *Automobile's* Tyre Bank.

14.4.4.3 The official tyre supplier will have 4 new wet tyres (2 front and 2 rear) available for each *Automobile* at each *Round*. From the commencement of qualifying onwards a maximum of 8 wet weather tyres (4 front and 4 rear) as marked by the *TD* may be used at that *Round*. These tyres may be allocated to that *Automobile's* Tyre Bank for that *Round*.

S14.5 Replacement Tyre

- 14.5.1 If a tyre is damaged during qualifying or a race and the *Competitor* wishes to replace it, they must notify the *TD* a minimum of 60 minutes prior to the start time of the next session. The *TD* has the authority to declare any damaged tyre not fit for use and prohibit its further use. In this case, the *TD* will remove that tyre from the Tyre Bank.
- 14.5.2 There will be no new replacement control tyres. Any replacement tyre from that *Automobile's* Tyre Bank must be marked for that *Automobile* at that *Round*. Permission to use a replacement tyre will be at the discretion of the *TD* or their nominee. This applies for both dry and wet weather tyres.
- 14.5.3 Any replacement tyre approved for use by a Pro Class *Automobile* must be marked for use on that *Automobile*. That *Automobile* must then start the next race at that *Round* from the rear of the Pro Class grid. If there is more than 1 such *Automobile*, they will be placed in order of qualifying results at the rear of the Pro Class grid.
- 14.5.4 Any replacement tyre approved for use by a Pro-Am Class *Automobile* must be marked for use on that *Automobile*. That *Automobile* must then start the next race at that *Round* with a 2 grid spot penalty. A maximum of 2 front and 2 rear tyres can be replaced at a *Round* and a maximum of 4 front and 4 rear tyres may be replaced for the *Championship*. Any further replacement tyres will result in that *Automobile* starting the next race at that *Round* from the rear of the grid.

S14.6 Table Previously nominated tyre usage

Round	Practice	Warm Up	Qualifying and Races
All	Yes	Yes	No

Note: The *TD* will be sole arbiter with regard to the interpretation and application of these tyre regulations and any decision made by the *TD* in this regard will not be the subject of any protest or appeal.

S15 FUEL

S15.1 Control Fuel

- 15.1.1 For the duration of a *Round*, each *Competitor* must only use the specified control fuel supplied by the official fuel supplier as detailed below or their appointed representative:

RaceFuels

Mark Tierney

BH: 0419 511 517

Email: info@racefuels.com.au

- 15.1.2 The fuel type supplied will be Elf Race 102 unless otherwise specified in the *Supplementary Regulations*.
- 15.1.3 Any chemical change or additive to the fuel is prohibited.
- 15.1.4 With the exception of ambient atmospheric air and the specified control fuel, no other substance may be added to the intake charge of the engine.

S15.2 Fuel Storage

- 15.2.1 Approved containers as supplied by the Fuel Supplier and as detailed in [Attachment B](#) must be used.
- 15.2.2 Any container used for storing or handling fuel must have the Hazard information as detailed in [Attachment B](#) affixed.

S15.3 Fuel Sampling

- 15.3.1 The *TD* or their nominee is entitled to take fuel samples from an *Automobile* at any time during a *Round*.
- 15.3.2 The *Competitor* must ensure that from the time the *Automobile* leaves its garage prior to the commencement of a session until it is released from *Parc Fermé* after that session that a minimum of 2.0 kg of fuel can be taken from the removal point (defueling coupling of the fuel cut-off valve) in the luggage compartment.

S15.4 Fuel Handling

- 15.4.1 Each *Automobile* is required to arrive at the *Event* with no fuel in the tank.
- 15.4.2 Fuelling and refuelling of an *Automobile* during practice, qualifying and a race is prohibited.
- 15.4.3 Unless authorised by the *TD*, refuelling outside of the *Automobile's* paddock garage/marquee is prohibited.
- 15.4.4 All *Automobile* refuelling and draining must take place via the "Fill and Drain" dry break fittings.
- 15.4.5 Any operation involving the handling of fuel requires grounding to earth of the *Automobile* and all equipment and at least 1 certified and full functioning 4.5 kg fire extinguisher.
- 15.4.6 Fuel may only be added into or removed from the fuel cell of the *Automobile* using a closed-circuit fuelling system manufactured by a specialist company and approved by the *TD* or their nominee.
- 15.4.7 Any work requiring the fuel cell to be opened may only be performed after all fuel has been removed from inside the fuel cell and with appropriate protection and fire extinguishers being present at the work area.
- 15.4.8 Smoking and hot work are prohibited when any operation involving fuel or the fuel cell is in progress.

S16 AUTOMOBILE MARKINGS

S16.1 Advertising Conditions

- 16.1.1 The advertising guidelines of the *FIA*, *Motorsport Australia* and general or legally regulated advertising bans must be followed.
- 16.1.2 Unless otherwise advised in writing by the *CM*:
 - 16.1.2.1 Any advertising surface that is not occupied as specified in [Attachment A](#) is available for the *Competitor's* own advertising labels.
 - 16.1.2.2 A *Competitor* must not advertise any partnerships/sponsorship with a company who is either in competition to Dr. Ing. h.c. F. Porsche AG, its parent or partner companies, the official *Championship* partner/s of Dr. Ing. h.c. F. Porsche AG or who are involved in a legal dispute with Dr. Ing. h.c. F. Porsche AG or a company associated with Dr. Ing. h.c. F. Porsche AG. Each *Competitor* is therefore obliged to notify any potential partnership/sponsorship to Dr. Ing. h.c. F. Porsche AG in advance. Dr. Ing. h.c. F. Porsche AG is entitled to prohibit a *Competitor* from advertising any partnership if the potential partner falls into one of the above two categories;
 - 16.1.2.3 The use of an advertisement for any company, their products, services or brands that are competitor products, services or brands of Dr. Ing. h.c. F. Porsche AG and/or Porsche Cars Australia (this includes Porsche Carrera Cup Australia), their associated companies or the *Championship* partners/sponsors on an *Automobile*, helmet, race suit and other *Driver* equipment, team vehicle or team clothing or any other kind of advertising for these companies, products or services is prohibited;
 - 16.1.2.4 The use of an advertisement for *Driver* coaching and/or development programs (other than the Porsche Junior) and any non-Porsche one-make race series are prohibited; and

16.1.2.5 The use of an advertisement for any company in the tobacco and sex industry, or political or religious advertising, or private betting and gambling operators on an *Automobile*, helmet, race suit and other *Driver* equipment, team vehicle or team clothing or any kind of advertising for these companies, products or services or anything that may be deemed by Dr. Ing. h.c. F. Porsche AG to bring the company and/or the *Championship* into disrepute is prohibited.

S16.2 Automobile Markings and Championship Identification

16.2.1 Unless specifically approved by *Motorsport Australia*, in addition to [Attachment A](#) of these regulations, each *Automobile* must comply with Technical Appendix - Schedule K of the *Motorsport Australia Manual*.

16.2.2 Each *Competitor* must display the *Championship* sponsor decals as supplied by the *CM*.

16.2.3 Any signage placed on an *Automobile* in the direct view of a TV Production on-board camera must have the prior written approval of the *CM*.

S16.3 Competition Numbers

The allocation of a competition number for each *Automobile* is solely the responsibility of the *CM*, which will maintain a register of each competition number allocated to, or reserved for, an *Automobile*.

S17 DRIVER APPAREL

S17.1 Standard of Apparel

Each *Driver* must wear apparel that complies with “International” in Table 1.1 of Technical Appendix - Schedule D of the *Motorsport Australia Manual*. This includes helmet, frontal head restraint, racing overalls, underwear, balaclava, footwear, socks and gloves which must be worn correctly at all times whilst the *Driver* is seated in the *Automobile* when it is in *Pit Lane* and on the *Track*.

S17.2 Reserved Signage on Racing Overalls

Each *Driver* is required to have signage as detailed below affixed to their racing overalls.

PORSCHE PAYNTER DIXON CARRERA CUP AUSTRALIA

Race Suit Signage Regulations

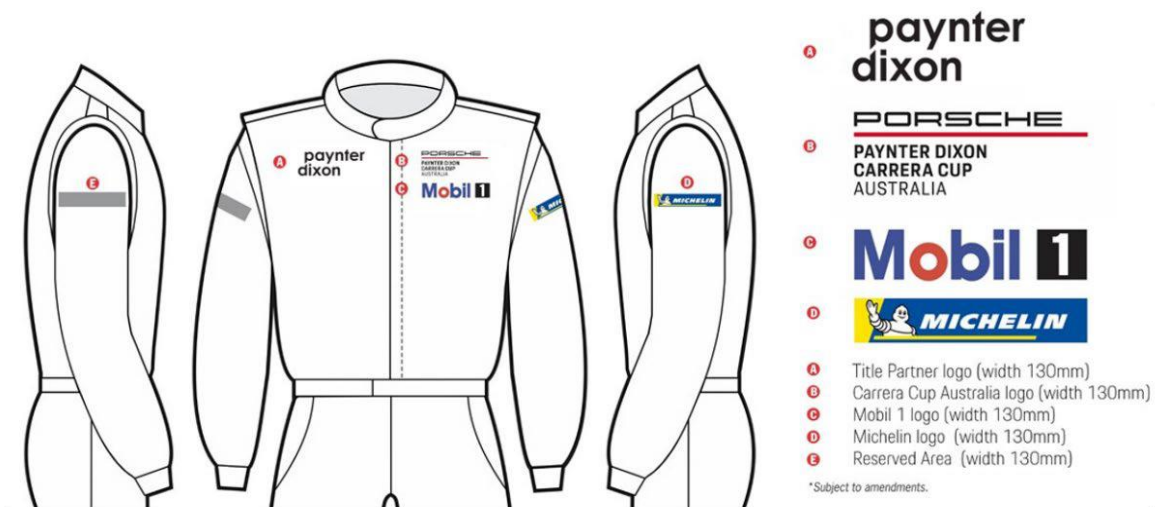

S18 TESTING

S18.1 Testing Restrictions

Unless approved by the *CM* in writing, testing of any competition *Automobile* and/or *Driver* deemed by the *CM* to be associated with the *Championship* is prohibited on any *Circuit* during the 7 days preceding a *Round*, other than private sessions sanctioned by the *CM*. For clarification, the 7 days commences at 0001 hours on the Saturday preceding the scheduled *Round*.

S18.2 Pre testing Procedures

18.2.1 Before any Team may undertake testing it is their responsibility to:

- 18.2.1.1 notify the *TA* (jesse.hammond@porsche.com.au) in writing with date, VIN and track no less than 5 working days before the date of the proposed test; and
- 18.2.1.2 obtain permission from the *CM* to conduct a Test day; which permission will not be unreasonably withheld.

S18.3 Testing Limits

There are no limits on testing outside of Articles S18.1 and S18.2.

S19 RAIN LIGHT

The rain light fitted to each *Automobile* must be illuminated at all times when the *Automobile* is running on wet-weather tyres or as directed by the *RD*.

S20 IN-CAR CAMERAS

S20.1 VBox Video HD2 Camera System

- 20.1.1 Each *Automobile* must be fitted with a VBox Video HD2 camera system.
- 20.1.2 It is prohibited to fit any additional on-board camera.
- 20.1.3 Each *Competitor* will be required to ensure that the camera is switched on and functioning in the correct manner prior to the *Automobile* entering the *Track* for each practice, *Passenger Ride*, qualifying, warm up and racing session at an *Event*.
- 20.1.4 Access to the camera must be provided to the *CM* appointed technicians at any time upon request.
- 20.1.5 No person other than the authorised *CM* appointed technicians may interfere with the camera, other than to remove and replace the USB storage device.
- 20.1.6 When requested, a *Competitor/Driver* must immediately provide the USB storage device to the *DSA* or *RD* or *DRD* upon request.
- 20.1.7 The USB storage device must be clearly identified with the *Automobile's* competition number.
- 20.1.8 1 team member per *Automobile* is permitted to remove and copy the vision from the USB storage device during *Parc Fermé*. If the vision is not on the USB storage device when requested/accessed by the *RD*, *DSA* or *DRD* that Team will be referred to the Stewards and a penalty may be imposed. At all other times it is prohibited to remove the USB storage device from the *Automobile*.

S20.2 TV Production Cameras

- 20.2.1 The *CM* reserves the right to install TV production in-car and on-board cameras on an *Automobile* and position signage within view of the camera.
- 20.2.2 Teams will be allocated signage area within view of the TV production in-car camera as per [Attachment C](#) which must be approved by the *CM*.

S21 GROUND CLEARANCE

- 21.1 It is prohibited to adjust the ride height of an *Automobile* by altering the static length of the front or rear spring during a qualifying session of a *Round*.
- 21.2 Any *Competitor* or team member found adjusting the ride height of the *Automobile* during a qualifying session of a *Round* will result in a penalty of *Disqualification* of the *Automobile* from that session being imposed.

S22 ON BOARD FIRE EXTINGUISHER

The fire extinguisher system fitted to the *Automobile* must be switched into position "Armed" and the red LED flashing from the moment the *Automobile* leaves its garage to travel to the marshalling area for each session and must not be switched off until the *Automobile* is returned to its garage or *Parc Fermé* after the session.

S23 TELEMETRY, DATA RECORDING SYSTEMS

- 23.1 Except for a built-in tyre pressure monitoring system that uses radio transmission for its functionality, the use of radio based information transmission in an *Automobile* (e.g. telemetry) is prohibited.
- 23.2 The *Competitor* may download but not delete data during a *Round*.
- 23.3 At any time during a *Round*, the *RD*, *DRD*, *TD*, *TA* and/or Stewards have the right to request and receive from a *Competitor* or *Automobile*, recorded *Automobile* data. This data may be analysed and provided to the Stewards for use as evidence in inquiries and hearings.
- 23.4 The *Competitor* must supply recorded data at the request of the *CM*.
- 23.5 The use of any laptop/computer connected to the *Automobile* is prohibited during any Qualifying session and Race from the time the *Automobile* enters the marshalling area until the *Automobile* is released from *Parc Fermé*.

S24 DRY TO WET PROCEDURE

S24.1 Prior to the *Automobiles* being called to the marshalling area.

If the *Track* is declared wet prior to the *Automobiles* being called to the marshalling area, Articles S24.2 and S24.3 will not apply.

S24.2 Before the race *Start*

- 24.2.1 In the event of the *Track* conditions changing from dry to wet, to the point that wet tyres are required, after the *Automobiles* have left the marshalling area but prior to the race *Start*, all *Automobiles* will be directed to the *Pit Lane*.
- 24.2.2 The only work permitted to be carried out on an *Automobile* while in the *Pit Lane* will be changing to wet tyres.

24.2.3 On completion of all *Automobiles* changing to wet tyres, each *Automobile* must proceed to the grid as instructed over *RMC*.

S24.3 During the race

24.3.1 In the event of the *Track* conditions changing from dry to wet, to the point that wet tyres are required during the race, the Safety Car will be deployed.

24.3.2 If it is determined that the *Track* will not dry quickly and less than 75% of the race distance has been completed, the race will be suspended with all *Automobiles* directed to the *Pit Lane*.

24.3.3 The only work permitted to be carried out on an *Automobile* in the *Pit Lane* will be changing to wet tyres.

24.3.4 On completion of all *Automobiles* changing to wet tyres, the order in which *Automobiles* are to line up behind the Safety Car at pit exit will be announced over *RMC*.

24.3.5 The procedure for resuming the race will be as detailed in the *CRSR* – Resuming a Race.

24.3.6 If it is determined that the *Track* will not dry quickly and 75% or more of the race distance has been completed, the race will be stopped and not restarted.

S25 PASSENGER RIDES

Any *Passenger* ride conducted must comply with the Motorsport Australia MSPRA Policy.

S26 JUDICIAL

S26.1 Demerit Point System

26.1.1 Each *Competitor* and *Driver* will commence the *Championship* with 12 demerit points.

26.1.2 If a *Driver* is found guilty of either a Code of Driving Conduct breach, or a behavioural breach, in addition to the penalty imposed by the Stewards, a demerit point penalty will be imposed, in accordance with the following:

Infringement	Infringement Level	Demerit Point Deduction
Code of Driving Conduct Breach	Low	1 Point
	Medium	2 Points
	High	3 Points
Behavioural Breach	Low	1 Point
	Medium	2 Points
	High	3 Points

26.1.3 It is the *Competitor's* responsibility to ensure the *Driver* and all associated team members (as determined by the *CA*), conduct themselves in a respectable manner at all times. Should the behaviour of a *Competitor*, *Driver* or an associated team member be deemed to be unacceptable, the *Competitor* will be referred to the Stewards.

26.1.4 If a *Competitor* is found guilty of a behavioural breach, in addition to the penalty imposed by the Stewards, a demerit point penalty will be imposed, in accordance with the table above.

26.1.5 If a *Competitor/Driver* loses a total of 12 or more demerit points during the *Championship*, the *Competitor/Driver* will be prohibited from entering any future *Events* in the *Championship*.

26.1.6 A *Competitor/Driver* who is prohibited to *Enter* any future *Event* of the *Championship* may be eligible to re-enter the *Championship* once they have met the requirements for re-entry, as determined by the *CA*.

26.1.7 The *CM* reserves the right to prohibit any *Competitor/Driver* from re-entering the *Championship*.

S26.2 Exceeding *Track* Limits

26.2.1 An Automobile identified by a Judge of Fact or a timing loop as having exceeded the *Track* limits may have the following penalty imposed:

26.2.1.1 During practice that lap time (and where appropriate the following lap time) deleted;

26.2.1.2 During qualifying that lap time (and where appropriate the following lap time) deleted;

26.2.1.3 During a race 5 seconds added to race time.

S27 2023 PORSCHE PAYNTER DIXON CARRERA CUP AUSTRALIA CHAMPIONSHIP CODE OF GOOD CONDUCT

27.1 The 2023 Porsche Paynter Dixon Carrera Cup Australia Championship is characterised by equality of opportunity and fairness in both technical and sporting terms. Each person involved in the *Championship*, i.e. *Participants*, officials and organisation, makes a significant contribution to how the *Championship* is perceived, both internally and by the public and to the atmosphere in the *Championship* through their conduct and their communication.

27.2 Each person involved is responsible for conducting themselves in such a way as to uphold and safeguard in the long term the professionalism that prevails in the 2023 Porsche Paynter Dixon Carrera Cup Australia, as well as the esteem in which the *Championship* and its *Participants* are held by the public. Moreover, fair and sporting *Competition* represents an important safety aspect for each *Participant* and is intended to avoid risk factors.

27.3 Each person involved agrees to acknowledge the philosophy of the 2023 Porsche Paynter Dixon Carrera Cup Australia and to comply with the Code of Good Conduct of the *Championship*.

27.4 Both on and adjacent to the *Track*, each person involved must:

comply with the Code of Good Conduct; and

treat each other *Participant*, official and *Organisers* respectfully; and

follow the laws and the rules of the sport, and exemplify and promote fairness and the of Good Conduct; and

neither express themselves nor behave in an insulting, offensive or abusive way, nor tolerate such expressions or modes of conduct, either in direct conversations, interviews, etc. or in other communication, e. g. press releases, posts in social media; and

always behave in the interests of safety and permanently cooperate in efforts to reduce risks; and

use resources in a sustainable way, giving priority to the well-being, safety and satisfaction of others before their own personal goal; and

always comply with the purpose of the sport; and

inform any other person who is involved if their conduct is not characterised by fairness, sportsmanship, respect and tolerance; and

cooperate with any other person involved so as to develop and improve the *Championship* and its status further on a continuous basis.

27.5 A *Participant* who is found to have committed one or more of the following may be denied participation in the 2023 Porsche Paynter Dixon Carrera Cup Australia Championship by the *CM* :

- failure to comply with the Code of Good Conduct; or
- breach any regulation; or
- draw attention to themselves through unsporting behaviour on and adjacent to the *Track*; or
- express themselves about or behave in a disrespectful way towards any other *Participant*, official, *Organiser*, etc.; or
- ignore any specification, instruction, meeting of the *Championship* organisation and/or other official body in the context of the organisation and holding of an *Event*; or
- ignore any agreement that has been reached (including between teams and *Drivers*) and do not meet obligations of performance; or
- do not act in the interests of the sport and/or the recognisable objective of undertaking the activities seriously in accordance with the *Rules* that have been acknowledged; or
- bring the *Championship* into disrepute.

ATTACHMENT A

Automobile Markings – Reserved Areas

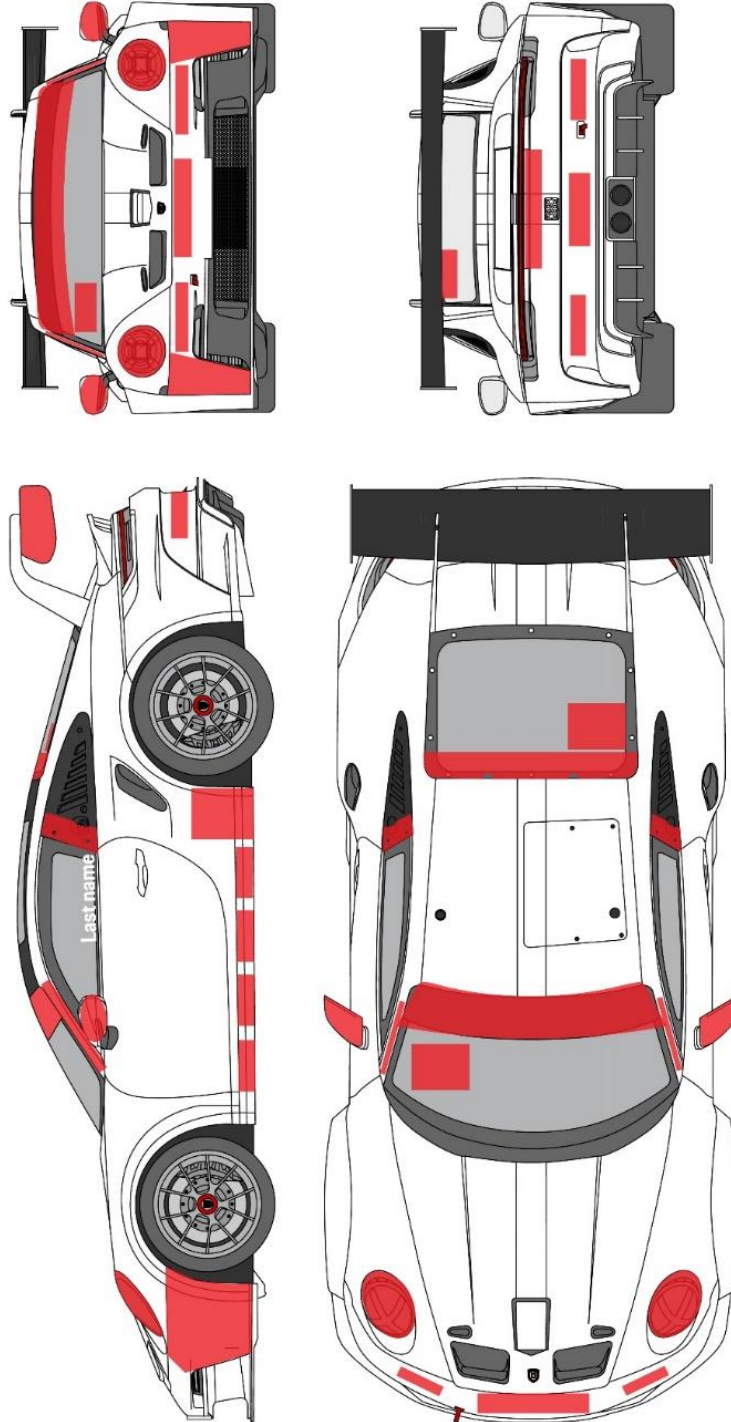

ATTACHMENT A

Automobile Markings – PRO

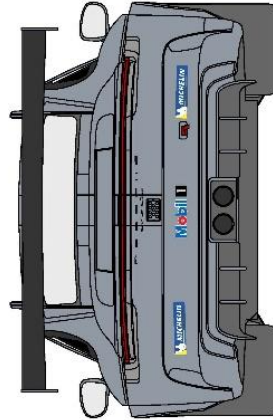

subjs
MSC
03 9894 7311
bianca@mscsigns.com.au

2023 - Carrera Cup Series Sponsor Placement - PRO

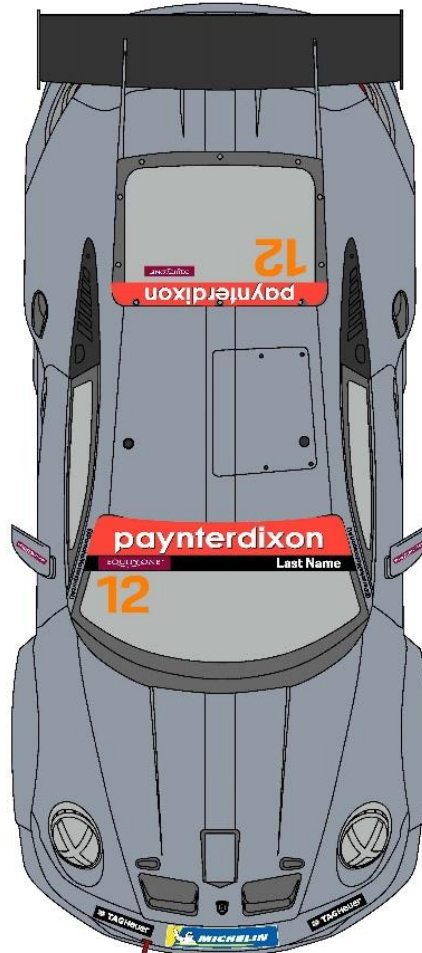
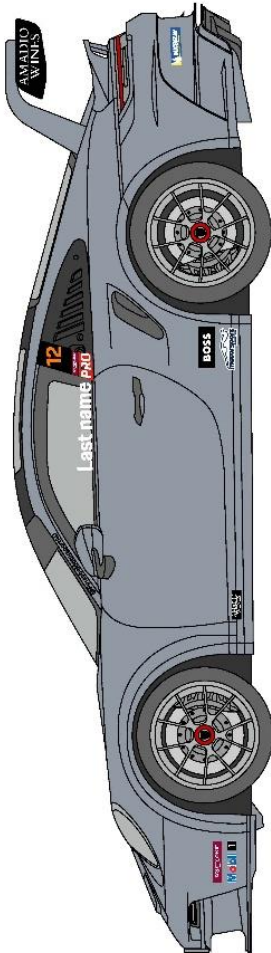

ATTACHMENT A

Automobile Markings – PRO-AM

2023 - Carrera Cup Series Sponsor Placement - PRO-AM

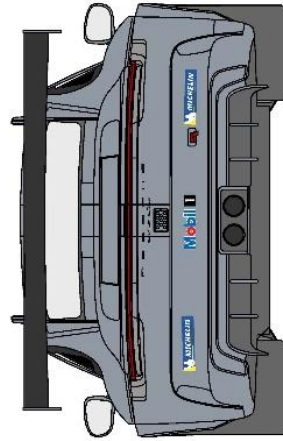

03 9894 7311
 bianca@mscsigns.com.au

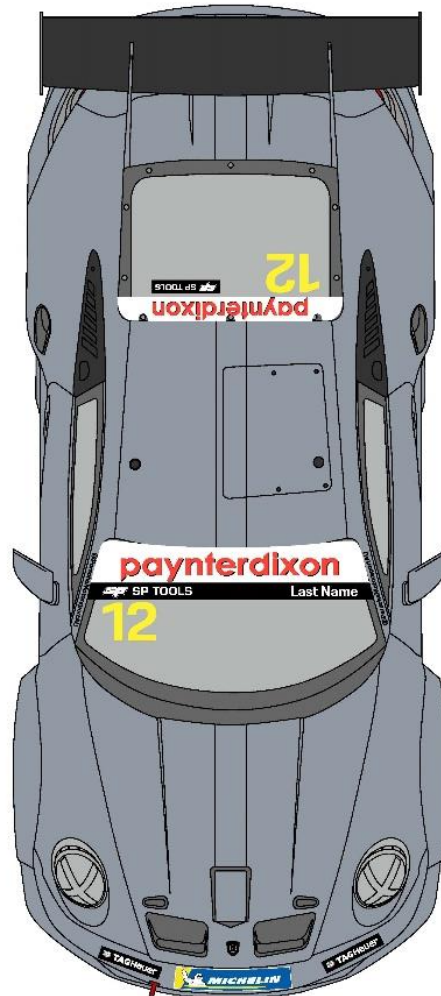
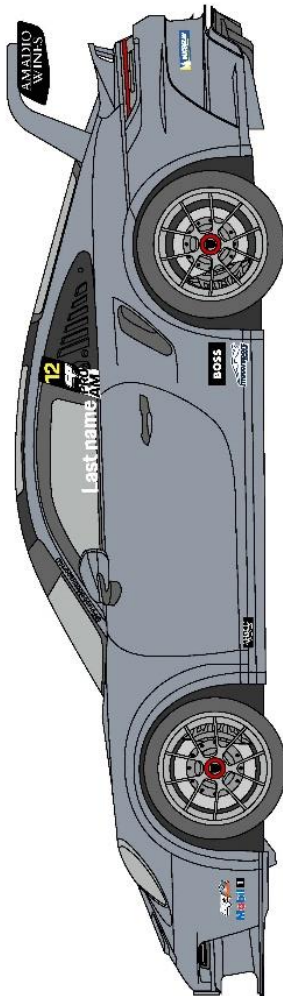

ATTACHMENT A

Automobile Markings – Michelin Junior

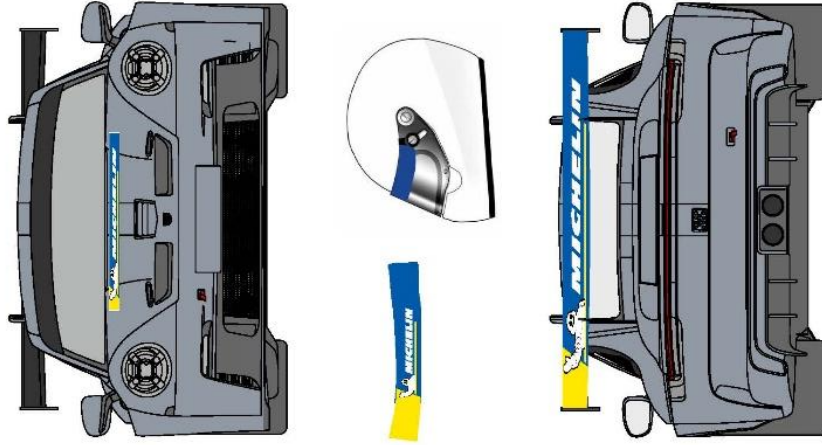

03 9894 7311
bianca@mscsigns.com.au

2023 - Carrera Cup Series Sponsor Placement - Michelin Junior

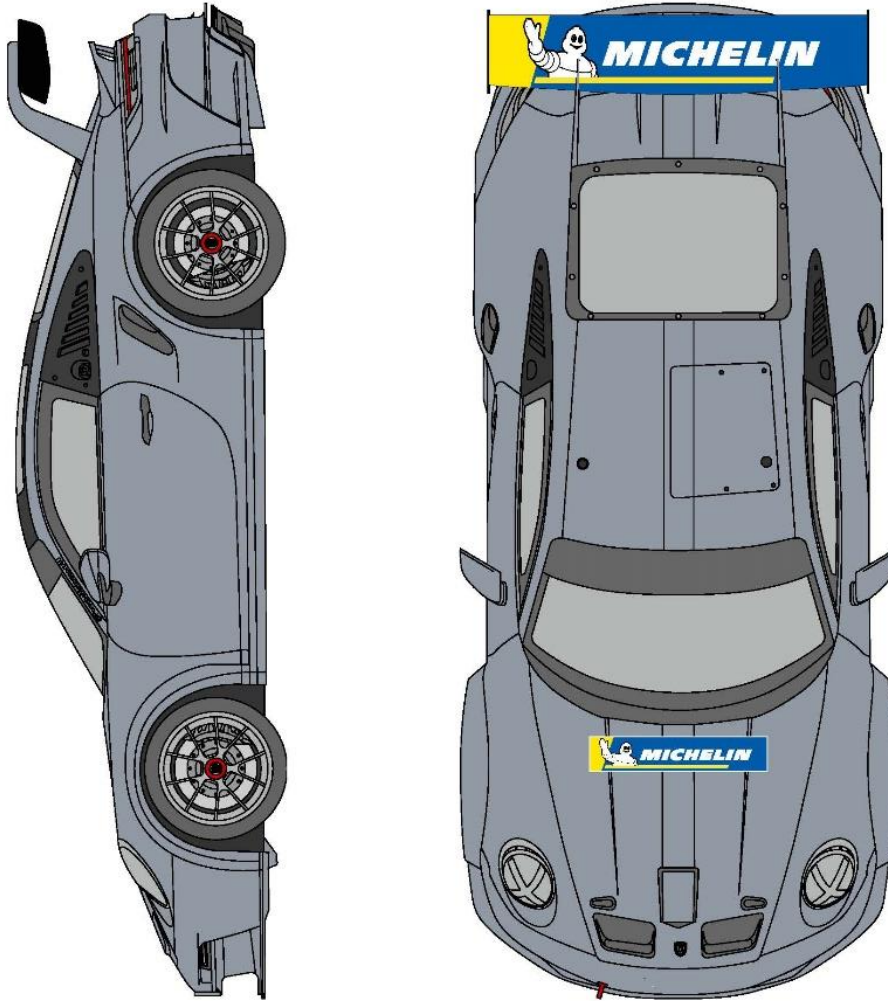

ATTACHMENT B

Fuel Container



ATTACHMENT C

In Car Camera Reserved Signage



The area indicated on the dash in white (400mm x 85mm) and the inside of the door coverings are allocated to a *Competitor* for the use of personal sponsors.

No other *Competitor* signage is permitted.

GENERAL TECHNICAL REGULATIONS

T1 PREAMBLE

Unless permitted in these Regulations, any modification is prohibited

Any addition or removal of material, heat treatment or coating to alter any property of a part or component and/or its dimension is prohibited.

Mounting a part in a different way or location than the original deliver condition is prohibited.

A permitted modification may only serve the intended purpose.

The installation of any permitted optional part or system must be in accordance with the manufacturer's instructions and approved by the *TD*. Any such installation will remain the sole responsibility of the *Competitor*.

If requested by the *TD*, a *Competitor* must remove any optional part or system.

With approval from *Motorsport Australia*, the *CM* reserves the right to amend and extend these regulations.

The decision of the *TD* will be final regarding interpretation of these regulations.

T2 PRINCIPLES OF THE TECHNICAL REGULATIONS

- 2.1 Each *Automobile* must comply with all requirements of each of the below unless they are clearly specified as being optional:
 - 2.1.1 Articles 251 and 277 (Group EII-SH) of Appendix J to the *Code*;
 - 2.1.2 These Technical Regulations;
 - 2.1.3 Technical Manual/s of the eligible *Automobile*;
 - 2.1.4 Technical information of Dr. Ing. H.c. F. Porsche AG;
 - 2.1.5 Software information of Dr. Ing. H.c. F. Porsche AG; and
 - 2.1.6 Spare parts catalogue/s of the eligible *Automobile*;
- 2.2 If there is any discrepancy between the requirements of these Technical Regulations and any relevant technical manual, technical information, software information or parts catalogue, then these Technical Regulations will take precedence.
- 2.3 Any requirement specified in a technical manual, technical information, software information and/or parts catalogue may be updated by Dr. Ing. H.c. F. Porsche AG at any time.
- 2.4 For software information, only the latest version is valid. However, "setups" (based on the latest version) may be varied within the parameters permitted by Dr. Ing. H.c. F. Porsche AG. Any requirement may be varied for any specific *Competition* by means of a Bulletin issued by the Stewards.
- 2.5 It is recognised that a spare part listed in a parts catalogue may be subject to a change of part number during the *Championship*. Therefore, subject to prior approval by Dr. Ing. h.c. F. Porsche AG Aftersales Department, a spare part which is identical to that shown in the parts catalogue (and which has the same function, working principle and location in the *Automobile*) but which bears a different part number may be used. Such approval will be at the sole discretion of Dr. Ing. h.c. F. Porsche AG and it is the responsibility of the *Competitor* to ensure such approval, where granted, is documented and retained for inspection by the *TD*.

- 2.6 Certain alternative parts which have a different part number to, but the same functions as, the original part in the *Automobile* or in the spare parts catalogue are permitted to be used for the original intended function and in the original intended position and must be checked by the *TD* prior to use.
- 2.7 An *Automobile* may only deviate from these Technical Regulations where agreed for development purposes on behalf of the *TA*. Each deviation must be referred for approval to the *TA* prior to use and may not involve any safety-critical modification nor provide any performance or competitive advantage.

T3 ELIGIBILITY

T3.1 Eligible *Automobiles*

- 3.1.1 Only a Porsche 911 GT3 Cup (Type 992) *Automobile* with a Race Vehicle Authorisation Certificate (RVAC) issued by *PCA* will be eligible to compete in the 2023 Porsche Paynter Dixon Carrera Cup Australia Championship (*Championship*).
- 3.1.2 Each *Automobile* must, without exception, comply with these Technical Regulations throughout all official on-Track activities.
- 3.1.3 Refer to [Attachment D](#) for General Description of Automobile Components.
- 3.1.4 Refer to [Attachment E](#) for *Automobile* specifications.

T3.2 Examination for Eligibility

- 3.2.1 The presentation of an *Automobile* for participation in any *Round* will be deemed to be an implicit statement by the *Competitor* of conformity with these Technical Regulations.
- 3.2.2 If the Technical Delegate (*TD*) suspects at any time that an *Automobile* does not comply with these Regulations, the *Competitor* or nominated representative must be so advised and given the opportunity to comment on the suspected or alleged ineligibility.
- 3.2.3 Any comment so made may be recorded by the *TD*, and subsequently may be presented at any Stewards' Inquiry or Hearing.
- 3.2.4 If the *TD* fails to receive an adequate comment on the suspected or alleged ineligibility, which the *TD* alone has sole discretion to consider as adequate or satisfactory, the *TD* may require the *Automobile* to be impounded and examined, including such dismantling as may be necessary, to determine the points of eligibility in question.
- 3.2.5 At the discretion of the Stewards and/or the *TD*, any component, part or *Automobile* may be sealed by the *TD* for later examination.

T3.3 Permitted Modifications

- 3.3.1 The only work which is permitted to be carried out on an *Automobile* is that necessary for its normal servicing or the replacement of parts worn through use or incident.
- 3.3.2 Any part worn through use or incident may only be replaced by an identical Porsche genuine part specified in the valid spare parts catalogue. The use of a component manufactured by Dr. Ing. H.c. F. Porsche AG for other groups of cars (e.g. Porsche road cars) is prohibited.
- 3.3.3 If not specifically permitted by these regulations, the use of any item described as "optional" in the parts catalogue is prohibited.
- 3.3.4 A standard fastening component such as a nut, bolt, washer, lock washer, spring washer or split pin may only be replaced with a Porsche genuine part.

- 3.3.5 The service and replacement intervals and adjustment values specified by Dr. Ing. H.c. F. Porsche AG (refer Technical Manual) must be adhered to.
- 3.3.6 Providing there is no competitive advantage, the TD may permit a modification that does not correspond to the series production status on any Automobile (e.g. attachment of a camera, radio installation).

T4 AUTOMOBILE DIMENSIONS

Each *Automobile* must comply with the following dimensions:

- Total length: 4585 mm \pm 15 mm
- Front track width: 1885 mm \pm 10 mm measured between the centre of the front wheel hubs
- Rear track width: 1885 mm \pm 10 mm measured between the centre of the rear wheel hubs
- Front overhang: 1036.0 mm \pm 15.0 mm measured from the middle of the front wheel to the leading edge of the Automobile (first point in the direction of the longitudinal axis including the front lip)
- Rear overhang: 1081.0 mm \pm 15.0 mm measured from the middle of the rear wheel to the rear edge of the Automobile (last point in the direction of the longitudinal axis including the exhaust – rear wing excluded)
- Wheelbase: 2468.0 mm \pm 15 mm measured at the centre of the wheel hubs

T5 COCKPIT

T5.1 Safety Cage

The safety cage as welded into the *Automobile* is mandatory and must not be modified. The DMSB Safety Cage certificate for the individual *Automobile* must be presented upon request from the *TD*.

T5.2 Windscreen

- 5.2.1 A heated windscreen as listed in the parts catalogue is permitted to be fitted as a replacement for the original part. The windscreen is permitted to be connected to the electrical system of the *Automobile* and the heating function is permitted to be used.
- 5.2.2 It is permitted to fit windshield protection tear-offs. Fitting will be checked during technical scrutineering and must be removed if requested by the *TD*.

T5.3 Seat

- 5.3.1 Each *Seat* must comply with the requirements of FIA Appendix J Article 253 – 16.
- 5.3.2 The *Seat* may be modified by the addition of original Sabelt seat padding shown in green and blue in [Attachment K](#).
- 5.3.3 Each padding shape may only be used in the specific and correct location and direction as shown in [Attachment K](#).
- 5.3.4 Additional padding at the head rest is permitted in accordance with the following conditions and at the discretion of the *TD*:
- 5.3.4.1 The foam used for the padding must be the same material as used on the head rest by the *Seat* manufacturer
- 5.3.4.2 The padding must be properly fixed to the *Seat*.
- 5.3.5 Any addition or removal of material below the surface shown in black on [Attachment K](#) is prohibited.

- 5.3.6 The original *Seat* mounting (track) must be retained and must not be modified.
- 5.3.7 A foam insert between the *Seat* and the *Driver* may be used subject to it being:
 - 5.3.7.1 in compliance with the requirements of FIA Appendix J Article 253-16;
 - 5.3.7.2 constructed from fireproof material or covered in fireproof material;
 - 5.3.7.3 coloured black; and
 - 5.3.7.4 approved by the *TD*.

T5.4 Safety Harness

A minimum '5 point' safety harness meeting the FIA 8853/2016 standard which is suitable for use with a Frontal Head Restraint system is mandatory.

T5.5 Driver Racing Net

Each *Automobile* must be fitted with the Driver Racing Net as specified in the valid spare parts catalogue and mounted in compliance with the official Dr. Ing h.c.F. Porsche AG mounting instructions.

T5.6 Driver Cooling System

- 5.6.1 It is permitted to fit a cooling system for a cooling vest to the *Automobile*.
- 5.6.2 The cool suit system may form part of the *Ballast* of the *Automobile* but not the *Driver Ballast*.
- 5.6.3 The mounting of the Driver cooling system must be located wholly within the *Cockpit*. The Driver cooling system must only be mounted using metal hardware on the *Ballast* mounting plate supplied by Porsche. Any mounting system must be capable of sustaining a force of 30G in an incident.

T5.7 Drinking System

- 5.7.1 A drinking system may be fitted for the *Driver's* hydration.
- 5.7.2 The bottle and associated plumbing are to be located wholly within the *Cockpit* and must not exceed 2 litres in capacity.
- 5.7.3 Only 1 drink bottle is permitted per *Automobile*.
- 5.7.4 The drink bottle must only be of proprietary manufacture and securely mounted and to the satisfaction of the *TD*.

T5.8 In-Car Cameras

- 5.8.1 Other than those fitted by personnel authorised by the television network for TV production purposes and approved by the *CM*, only the Vbox Video HD2 camera system as determined by the *TD* is permitted.
- 5.8.2 The installation of the camera and associated components must be to the satisfaction of the *TD* and Chief Scrutineer.
- 5.8.3 Unless authorised in writing by the *CM*, it is prohibited to use the live streaming capability of the Vbox Video HD2 camera system.
- 5.8.4 The *Competitor* must comply with any direction from the *CM* for a TV camera to be fitted to their *Automobile*.

T5.9 Timing Transmitter

The location of the Dorian Data 1 transmitter must be in the recessed section of the right rear floor pan as fitted from delivery. It is prohibited to alter the original mounting position of the bracket or Dorian.

T5.10 Fire Extinguisher

The fire extinguishing system, compliant with FIA Article 253.7.2 of Appendix J to the *Code*, as supplied originally with the *Automobile* and its installation position must remain unchanged.

T5.11 Coachwork

The *Coachwork* including windows must remain as supplied by the factory. Additionally, the rear window must remain fixed with the original type of fixing.

T5.12 Ventilation

5.12.1 Only the factory-fitted ventilation pipe (NACA intake on the front opening hood) and the existing original ventilation opening in each rear side window are permitted for *Cockpit* ventilation. These may not be covered and/or blocked at any time when the *Automobile* is fitted with dry weather tyres on the *Track*.

5.12.2 If the *Automobile* is fitted with wet weather tyres, it is permitted to cover the ventilation slots in the rear side window openings with clear heli tape.

5.12.3 It is prohibited to cover or block the NACA intake on the front hood whilst the *Automobile* is on the *Track* regardless of which tyre is fitted.

T5.13 Air Intake Blanking

It is prohibited for air intakes in the front bumper bar to be partially or completely blanked.

T5.14 Roof Hatch

The roof hatch to facilitate access to the *Driver* is connected to the roof with 7 live locks which must always be accessible. Foiling or painting of the live locks is prohibited.

T6 TRANSMISSION/DIFFERENTIAL

6.1 The ramp breakover angle of the differential lock is 52° (traction) and 35° (overrun), refer to [Attachment J](#).

6.2 The number of friction plates and the assembly order must comply with the specification in the Technical Manual.

6.3 The fitted friction plates must comply with the part number, allocation and specification in the parts catalogue.

6.4 If the transmission emergency function has been switched on, the *Automobile* must return to the *Pit Lane* and cannot re-join the *Track* until this function has been deactivated.

T7 ENGINE TYPE

Unless with prior written approval of the *TA*, the engine must respect the year of the *Automobile* at all times, refer to [Attachment E](#).

T8 ENGINE AND TRANSMISSION REPAIRS

T8.1 Duty of Notification

8.1.1 The *Competitor* must notify the *TA*, in writing, of any required repairs to the below listed components by submitting the Request for Repairs Form. (Sample shown in [Attachment F](#)).

8.1.2 Unless prior written confirmation has been received from the *TA*, any work to these components is prohibited to be undertaken by a *Competitor*. The *TA* reserves the right to inspect any *Automobile* prior to this authority being granted.

8.1.3 Any breach of the requirement for notification will be referred to the Stewards.

T8.2 Repairs

- 8.2.1 All work involving the following items and/or breaking of *Seals* is only to be conducted once formal written approval is given by the *TA*, refer [Attachment F](#):
- 8.2.1.1 Crankcase
 - 8.2.1.2 Crankshaft
 - 8.2.1.3 Pistons
 - 8.2.1.4 Cylinder head
 - 8.2.1.5 Camshaft
 - 8.2.1.6 Gearbox
 - 8.2.1.7 Differential
- 8.2.2 Once the *TA* is satisfied that the appropriate procedures for repair have been complied with, the *TD* will fit the required *Seals*.
- 8.2.3 The above protocol is to ensure continuity and parity between *Automobiles*.
- 8.2.4 Any breach of the above direction will be referred to the Stewards.

T9 SEALS

- 9.1 The following *Seals* are affixed to each *Automobile* at the works:
- 9.1.1 Left valve cover – 1 *Seal*;
 - 9.1.2 Right valve cover – 1 *Seal*; and
 - 9.1.3 Connector for ECU wiring harness – 2 *Seals*.
- 9.2 The *TD* or Porsche (ex works) may affix further *Seals*.
- 9.3 Each *Seal* must not be damaged, changed or reproduced.
- 9.4 The responsibility to ensure that each correct *Seal* is fitted and is not damaged prior to any *Track* activity rests solely with the *Competitor*.
- 9.5 The *Competitor* of an *Automobile* found not to have the correct *Seals* fitted or if it is determined that a *Seal* has been tampered with, may be referred to the Stewards.
- 9.6 Unless a written request has been forwarded to the *TA* and the *TA* has given written permission for the *Seals* to be removed, the *Competitor* of an *Automobile* found not to have *Seals* fitted may be referred to the Stewards.
- 9.7 At all times, the *TD* will be a Judge of Fact in respect of any *Seals* fitted to an *Automobile*.

T10 SUSPENSION

T10.1 Suspension

- 10.1.1 The suspension must only be adjusted within the existing tolerances. All original parts, including replacement parts, must be retained in their original fitted location. The maximum permissible thickness of shims on the control arms for each *Circuit* are:

Front Axle 20.00 mm Rear Axle 15.00 mm	Front Axle 19.00 mm Rear Axle 13.00 mm	Front Axle 18.00 mm Rear Axle 11.50 mm
Hidden Valley	Mount Panorama	Phillip Island
Reid Park, Townsville	Albert Park	Sydney Motorsport Park
Sandown	The Bend Motorsport Park	
Surfers Paradise	Adelaide Parklands	
Queensland Raceway		
Winton		

- 10.1.2 The non-removeable spacer (part number 9F1.505.184) of the rear lower control arm will be included when determining the combined thickness of the camber spacer washers.
- 10.1.3 A change to the maximum permissible combined thickness of the spacer washers in the front and rear axle control arms and/or camber values can be announced by a Bulletin at any time before or during an *Event*.
- 10.1.4 It is permitted to fix the camber shims in position with aluminium tape.
- 10.1.5 Each bearing point of the front and rear control arms must be left in the position in which they are delivered.
- 10.1.6 The adjustment of the eccentric screw connecting the front top arm to the top of the front upright within its specified setting range is permitted.
- 10.1.7 It is prohibited to adjust the length of the front castor arm.

T10.2 Dampers and Springs

- 10.2.1 Only the factory-installed type of shock absorber and spring in their original condition are permitted to be used.
- 10.2.2 The original delivery condition of the bump stops of the front and rear shock absorbers must not be modified in any way.
- 10.2.3 The *TD* may, at any time, request the removal of the dampers and springs from any *Automobile* for the purpose of testing and/or eligibility checking. The *TD* may require the dampers and springs to be taken to another location for testing.

T10.3 Ground Clearance

- 10.3.1 The minimum ground clearance of the ready-to-drive *Automobile* with the *Driver* or *Driver* compensation weights in the *Automobile* and fitted with slick tyres at 2.0 bar (29 psi) +/- 0.1 bar (1.45 psi) air pressure must not be less than the specified dimension, as measured at the specified measuring points, at any time during an *Event*.
- 10.3.2 The ground clearance of the front axle must be a minimum of 72 mm measured from the mounting bolts of the cross member/*Bodywork* (as shown in [Attachment G](#)) to the reference surface with the following requirements:
- 10.3.2.1 The reinforcement sleeves (part number 9F1.407.371) must be fitted on the subframe;
- 10.3.2.2 The mounting bolts (part number WHT.008.757) must be unmodified and undamaged;
- 10.3.2.3 If the height of the mounting bolt head is less than 11.8 mm, the difference will be taken into account.

- 10.3.3 The ground clearance of the rear axle must be a minimum of 106 mm measured from the machined surface in the direction of travel on the side section of the rear axle (as shown in [Attachment G](#)) to the reference surface.
- 10.3.4 The reference surface is the measuring plate in the technical scrutineering area. The measuring plate is available for teams to check the ground clearance of their *Automobile* at any time.
- 10.3.5 The ground clearance may be changed within the existing adjustment range.
- 10.3.6 The minimum ground clearance of the ready-to-drive *Automobile* is checked using an appropriate height gauge for the axle to be measured. If the appropriate height gauge can be moved under the measuring points described above, this confirms compliance with the minimum height requirement. The *TD* may also use another instrument, e.g. callipers, depth gauge, to measure the ground clearance.
- 10.3.7 Compliance will be as determined by the *TD*.
- 10.3.8 If a measurement is less than the minimum required, the *TD* may take another measurement with any tyres used in the session and may request the *Driver* to be in attendance instead of equalisation weights..
- 10.3.9 Each *Automobile* that records a height less than the stipulated minimum will incur a penalty. The penalty for the first breach will be *Disqualification* from the results of that session. The penalty for any subsequent breach of the minimum height may include *Disqualification* from the *Round*.

T10.4 Anti-Roll Bars

- 10.4.1 Provided that 1 coupling rod of the respective roll bar is completely removed the anti-roll bars are permitted to be unhooked. Only the respective settings options given in the Technical Manual are permitted to be used.
- 10.4.2 The axial clearance of the anti-roll bars on the front and rear axles must be less than 1.0 mm. Designated shims listed in the spare parts catalogue are permitted to be used to achieve the required axial clearance.

T11 BRAKES

- 11.1 The brake system and components must comply with [Attachment E](#).
- 11.2 The use of ABS or any system operating similar to an ABS system is prohibited.
- 11.3 It is prohibited to fit endurance brake calipers to an *Automobile* even if they are listed in the parts catalogue.

T12 TELEMETRY, DATA RECORDING SYSTEM AND ECU

T12.1 Telemetry

The use of telemetry is prohibited.

T12.2 Data Recording System

- 12.2.1 The Cosworth data acquisition system as supplied originally with the *Automobile* is the only data acquisition system permitted.
- 12.2.2 This system must be installed as original without modification.
- 12.2.3 Except for an installation setup by the *CM*, any additional electrical connection to the *Automobile's* wiring harness is prohibited.
- 12.2.4 The Cosworth system is assigned to the VIN/Chassis Number and must not be exchanged.
- 12.2.5 Only the setups approved by Porsche AG are permitted to be used for the duration of a *Round*.

- 12.2.6 Unless otherwise approved by the *TA*, only Cosworth Toolset software may be used.
- 12.2.7 Unless authorised by the *TA* in writing, where the *TA* requires an additional part or system to be fitted for development purposes, the *Competitor* is prohibited to access any of the associated data.

T12.3 ECU and Wiring Lomm

- 12.3.1 The Bosch Motronic MS6.6 NG electronic control unit coded and sealed by *PCA* is the only unit to be used.
- 12.3.2 The Bosch Motronic MS6.6 NG electronic control unit including the complete wiring loom must be used without being changed.
- 12.3.3 The *TA* reserves the right to check or exchange the Bosch electronic control unit or record the engine characteristic data at any time during a *Round*.
- 12.3.4 The *TA* reserves the right to reprogram the Bosch electronic control unit and to Seal the plug-in connectors for reading the engine control unit at any time during a *Round*. This is to ensure that the status of the program and data is identical for each participating *Automobile*.
- 12.3.5 The *Competitor* is responsible for ensuring that the wiring and sensors that provide signals to the ECU data monitor are adequately maintained and remain working at all times.
- 12.3.6 If an engine control unit has the capability of traction control, the *Competitor* must inform the *TA* in writing of the VIN and ECU number. Traction control must be disabled.

T13 WHEELS

- 13.1 Only the wheels detailed in [Attachment E](#) are permitted.
- 13.2 Each *Competitor* must have a minimum of 3 full sets of wheels for each *Automobile*.
- 13.3 Each wheel must be fitted with original specified pressure and temperature sensors and valve cap during each *Track* session. Only the use of a valve cap that prevents the passage of air is permitted.
- 13.4 Except for any functional surface (rim bed, contact area of wheel nut, mounting surface of the wheel), the wheel rim is permitted to be painted. The friction strips on the inside of the rim must remain functional and must not be treated in any way.

T14 AUTOMOBILE WEIGHT

T14.1 Minimum Weights

- 14.1.1 The combined weight of the *Automobile* and its *Driver* (including apparel) must be a minimum of 1380 kg.
- 14.1.2 The weight of the *Automobile* including any *Ballast* and cool suit system approved by the *TD* but without the *Driver* or any *Driver* equalisation weight must be a minimum of 1295 kg.
- 14.1.3 The weight of the *Driver* including any apparel required by Technical Appendix – Schedule D must be a minimum of 85 kg.
- 14.1.4 If a *Driver* and their apparel weighs less than 85 kg, a *Driver* equalisation weight must be added to the *Automobile*. For example, if a *Driver* and their apparel record a weight of 83 kg, a *Driver* equalisation weight of 2 kg must be added to the *Automobile*.
- 14.1.5 The *Ballast* mounting plate must be installed in the *Automobile* at all times.

- 14.1.6 Any *Driver* equalisation weight or *Automobile Ballast* weight must be fixed to the top of the mounting plate located in the designated fixing points in the position of the *Passenger Seat* to the floor of the *Cockpit* (refer [Attachment I](#)).
- 14.1.7 Weight may be checked after each official qualifying session and after each race on the scales provided by the *CM* at each *Round*. The weight recorded on these scales will be considered to be fact and will not be the subject of any Appeal or Protest.
- 14.1.8 Each *Automobile* that records a weight less than the stipulated minimums will incur a penalty. The penalty for the first breach will be *Disqualification* from the results of that session. The penalty for any subsequent breach of the minimum weight may include *Disqualification* from the *Round*.

T14.2 Ballast

- 14.2.1 *Automobile Ballast* and *Driver* equalisation weight must be original Dr. Ing. H.c. F. Porsche AG *Ballast* weights installed on the auxiliary weight base plate at the position of the passenger *Seat* in accordance with the illustration in [Attachment I](#).
- 14.2.2 The *Ballast* weights are identified by part numbers in the spare parts catalogue and the reference table in [Attachment L](#).

T14.3 Weighing Process

- 14.3.1 The *TD* may nominate an *Automobile*, *Driver*, or *Automobile* and *Driver* for weighing, normally after a qualifying session or a race.
- 14.3.2 After nomination, the *Automobile* and *Driver* must proceed immediately by the shortest route to the official scale in the technical check area or other designated place.
- 14.3.3 Except for any action approved by the *TD*, it is prohibited to add or remove any substance to/from the *Automobile* or *Driver* from the time of nomination until the termination of the weighing process.
- 14.3.4 The *TD* will advise whether the *Automobile* is to be weighed with or without the *Driver*.
- 14.3.5 The *Driver* must stay with the *Automobile* until released by the *TD*.
- 14.3.6 If the *Driver* is to be weighed separately, once the *Driver* leaves the weighing area this will be deemed as acceptance of their recorded weight.
- 14.3.7 If an *Automobile* is presented for weighing with lost or damaged parts, the *TD* will determine which, if any, parts must be replaced prior to the *Automobile* being weighed.
- 14.3.8 Weighing will take place on the official scale/s provided by the *CM* at each *Round* which are also available for use by a *Competitor* to check their *Automobile* throughout the *Round*.
- 14.3.9 The *TD* will request the team to push the *Automobile* onto the scale. Once the *Automobile* is in the position requested by the *TD*, then all personnel must leave the area.
- 14.3.10 The official scale/s are "scales of fact" and any weight recorded is not subject to protest or appeal.
- 14.3.11 Following weighing, a *Competitor*, *Driver* or team member may request the weight recorded for their *Automobile*.
- 14.3.12 If an *Automobile* and/or *Driver* is found to be below the required minimum weight, the weighing procedure will immediately be repeated on the same scale, in the same conditions and with the same measuring method. The maximum value will be used as the actual recorded weight.

T15 LUBRICANTS

T15.1 Engine

- 15.1.1 Only Mobil 1 ESP X3 0W40 engine oil may be used in the engine.
- 15.1.2 The addition of any additives or chemical changes to the engine oil are prohibited.

T15.2 Transmission

- 15.2.1 Only Mobilube 1 SHC 75W90 transmission oil may be used in the gearbox.
- 15.2.2 The addition of any additives or chemical changes to the transmission oil are prohibited.
- 15.2.3 No less than the minimum quantity of transmission oil in the gearbox as specified in the Technical Manual must be used at all times during any *Round*.

T15.3 Oil Samples

Random oil samples may be taken during the season to ensure uniformity and the results of these oil samples will be available to the respective *Competitors*.

T16 AERODYNAMIC DEVICES

- 16.1 The original position of the wing section is permitted to be changed within the specified scope for adjustment provided by the Technical Manual.
- 16.2 Unless advised otherwise by the *TD*, taping over of any slot in the *Bodywork*, wing or other permanent part, joint and opening is prohibited.
- 16.3 It is permitted to tape over the full area of each headlight lens with transparent Heli tape.
- 16.4 The use of the front air scoop (part number 9F1.407.811 and 9F1.407.812) will be advised by the *CM/TA* for each *Round*. Both scoops must be fitted or removed. It is prohibited to have only one scoop fitted.
- 16.5 If the front air scoops are removed the *Competitor* must monitor the front brake temperature and wear. It is recommended to fit caliper temperature stickers to each front caliper and brake temperature paint on each front rotor.
- 16.6 The front air scoops for each *Automobile* must be taken to each *Round*.
- 16.7 The *CM* may determine that the front scoops must be fitted, in which case a Bulletin will be issued;
- 16.8 It is permitted to secure the 2 halves of the rear brake air duct element (part numbers 9F1.615.457, 9F1.615.458, 9F1.615.447 and 9F1.615.448) using a maximum of 3 cable ties around each element.

T17 EXHAUST SYSTEM

- 17.1 Each Automobile must be equipped with a catalytic converter as supplied by Dr. Ing. h.c. F. Porsche AG.
- 17.2 Exhaust System Nr 1 ('Supercup' system) is to be fitted as standard and Exhaust System Nr 2 (centre rear muffler and attachments) must be taken to each *Round*. Refer [ATTACHMENT H](#).
- 17.3 Unless specified otherwise in the *Event Regulations* for a specific *Round*, the Exhaust System to be fitted at each *Circuit* must be as per the table below:

Circuit	Exhaust System
Albert Park	Nr 1
Hidden Valley	Nr 1
Reid Park, Townsville	Nr 1
The Bend Motorsport Park	Nr 1
Sandown	Nr 2
Mount Panorama	Nr 1
Surfers Paradise	Nr 1
Adelaide Parklands	Nr 1

T18 COOLING SYSTEM

- 18.1 Where Glycol based corrosion protection is used, the volume of corrosion protection added must be limited to a maximum of 12% of the cooling system capacity.
- 18.2 The cooling system capacity is 22 litres, therefore the recommended fill method is 20 litres water plus 2 litres corrosion protection.
- 18.3 The *TD* or their nominee may take samples and test concentration at any time during the *Event*
- 18.4 Corrosion protection Part Number 9F0100628 is recommended.

ATTACHMENT D

General Description of Automobile Components

The following is a general description of the various components of an eligible *Automobile*.

For technical requirements refer to [Attachment E](#) – Recognition Document.

The Automobile

Porsche 911 GT3 Cup (992)

Single seated, near standard-based vehicle based on the Porsche 911 GT3

Engine

Water cooled six-cylinder boxer engine

Displacement: 3996 cm³

Stroke: 81.5 mm

Bore: 102 mm

Max revs: 8750 rpm

Single throttle butterfly system

Intake manifold with 2 resonance flaps

Dry sump lubrication with oil-water exchanger

Race exhaust system with supplied catalytic converter

ECU: Bosch MS 6.6

Single mass flywheel

Elf 102 Race fuel

Power Transmission

Six-speed sequential dog-type gearbox

Internal pressure-oil lubrication with active oil cooling via oil-water heat exchanger

Mechanical limited slip differential

Three-plate sintered metal race clutch

Paddle shift with electronic shift barrel actuator

Brakes

Two independent brake circuits incorporating front and rear axle brake pressure sensors

Only standard master brake cylinders are permitted for the 2 brake circuits on the front axle (diameter: 19.1 mm) and rear axle (diameter: 15.9 mm)

Driver adjusted brake force distribution via brake balance system

Racing brake pads

Optimised brake ducts

Ergonomic brake pedal positioning

Front axle: One piece, aluminium, 6-piston fixed calipers

Internally vented steel brake discs (380 mm diameter, 32 mm thick) mounted on aluminium disc bells

Rear axle: One piece, aluminium 4-piston fixed calipers

Internally vented steel brake discs (380 mm diameter, 32 mm thick) mounted on aluminium disc bells

Wheel Suspension

Forged control arms and top mounts

Stiffness optimised

Heavy duty spherical bearings with dust protection

Wheel hubs with centre-lock wheel nut

Shock absorbers with motorsport specific valve characteristic

Double blade type adjustable anti-roll bars

Tyre pressure monitoring system

Front axle: Double wishbone front suspension

Adjustable ride height, camber and toe

Electric power steering with manual function to ease car manoeuvring

Rear axle: Multi-link rear suspension

Adjustable ride height, camber and toe

Motorsport drive shafts optimised for reliability and durability

Wheels and Tyres

Single piece light alloy rims according to Porsche specification and design with centre lock

Front axle: 12J x 18 ET 23.5 mm

Rear axle: 13J x 18 ET 44.5 mm

Bodywork

Lightweight body featuring intelligent aluminium-steel composite design

Integrated (welded) safety cage in accordance with FIA regulations

Front cover with integrated quick-release fasteners, cooler exit-air duct and central air intake for *Cockpit* ventilation

Removeable rescue hatch in accordance with latest FIA safety regulations

Mounting points for lifting device

Fenders with extensions

Widened front bumper with spoiler lip

Rear *Bodywork* with integrated rain light in accordance with FIA regulations

Lightweight exterior:

Carbon fibre reinforced plastic doors with quick release push button

Carbon fibre reinforced plastic rear lid with integrated quick release fasteners

Removable carbon fibre reinforced plastic adjustable rear wing with “swan neck” mounting (11 positions)

Polycarbonate windows with hard coating

Rear underbody panelling with NACA ducts for brake, driveshaft and shift barrel actuator cooling

Modified 911 *Cockpit*:

Carbon fibre reinforced plastic interior trim panels

Ergonomic digital touch panel with multi-colour backlight aligned towards *Driver*

Multifunctional carbon fibre reinforced plastic motorsport steering wheel with quick release coupling, shift paddles and illuminated push buttons

Adjustable steering column with steering angle sensor

Safety nets (Centre and *Driver's* side) in accordance with the latest FIA safety regulations

Optimised *Cockpit* ventilation featuring airflow directed at the *Driver*

Racing bucket *Seat* in accordance with FIA Standard 8862/2009

Infinite longitudinal adjustment, two positions for height and inclination adjustment

Padding system in three sizes to adapt *Seat* to individual *Drivers*

Preparation for *Seat* ventilation

Six point racing safety harness

FT3 safety fuel cell (approx. 110 litres) and dry break couplings for fuelling and draining using a fully enclosed system

“Fuel cut-off” safety valve in accordance with FIA regulations

Integrated air jack system (three jacks) with valve mounting points on either side of the Automobile

Colours:

Exterior: GT silver metallic (M7Z)

Interior: GT silver metallic (M7Z) without clear lacquer finish

Rims: Platinum semi matt (0B5)

Rear wing: Naked carbon

Electrical

10.3” Porsche colour display

Porsche power box

Fire extinguisher system (extinguishing agent: NOVEC gas)

Lightweight 12 V, 60 Ah battery (LiFePO4), leak proof installed in *Co-Driver's* footwell

Digital touch panel with multi colour backlight

175 A alternator

Single arm windscreen wiper with direct drive (intermittent and continuous operation)

Three additional centre console switches for additional power consumers

Data connection (data logger, video system)

LED lighting system

Main headlights

Daytime running lights

Tail lights

Rain light in compliance with FIA homologation regulation

ATTACHMENT E

Recognition Document

**2023 CARRERA CUP
APPROVED VEHICLE SPECIFICATION
RECOGNITION DOCUMENT**

This form details the approved specifications of the *Automobile* model and shall be referred to as the “Recognition Document”.

Model Type: 911 GT3 Cup (992)
Model Year: 2021-2022-2023 CUP

SECTION 1 - CHASSIS

1.1 CHASSIS FRAME		
Description:	Monocoque integrated chassis and body	
Manufacturer:	Porsche	
Material:	Aluminium-Steel Composite	
1.2 FRONT SUSPENSION		
Description:	Double wishbone front suspension	
Spring medium:	Double Coil Springs (main and helper springs)	
Damper Type:	Oil/Gas	Adjustable: No
Anti-sway bar:	Steel – Double Blade Type	Adjustable: Yes
Suspension adjustable:	Height – Via spring seat	Method: Thread
1.3 REAR SUSPENSION		
Description:	Multi-Link with Solid Mounted Sub frame	
Spring medium:	Double Coil Springs (main and helper springs)	
Damper type:	Oil/Gas	Adjustable: No
Anti-sway bar:	Steel – Double Blade Type	Adjustable: Yes
Suspension adjustable:	Height – Via spring seat	Method: Thread
1.4 STEERING		
Type:	Electric power steering	Make: Porsche
1.5 BRAKES		
	Front	Rear
Type:	Disc	Disc
Dimensions:	380 x 32	380 x 30
Part Nr:	Left: 9F1615283A Right: 9F1615284A	Left: 9F1615583A Right: 9F1615584A
Material of disc	Multi piece Steel	Multi piece Steel
No. Pistons per Caliper:	6	4
Actuation:	Hydraulic	Hydraulic
Caliper:	Porsche	Porsche
Adjustable bias	Yes	
Brake Pads	Brand: Brembo Part No: 9F1615432	Brand: Brembo Part No: 9F1615432B
Master Cylinders	Standard: 19.1 mm diameter	Standard: 15.9 mm diameter

SECTION 2 - ENGINE

2.1 ENGINE			
Make:	Porsche		
Model:	MA275		
No. cylinders:	6	Configuration:	Flat
Cylinder Block-material:	Aluminium	Four Stroke:	Yes
Bore - Original:	102 mm		
Stroke - original:	81.5mm		
Capacity - original:	3996 cm ³		
Cooling method:	Liquid		
2.2 CYLINDER HEAD			
Make:	Porsche		
No. of valves/cylinder-	Inlet: 2	Exhaust:	2
No. of ports total:	Inlet: 6	Exhaust:	6
No. of camshafts:	4	Drive:	Chain
Valve actuation:	Bucket with Hydraulic Lifters		
Spark plugs/cylinder:	1		
2.3 LUBRICATION			
Method:	Dry sump		
Oil tank location:	Front of Engine		
Dry sump pump type:	Gear		
Location:	Crankcase & Cylinder Heads		
Oil cooler standard:	Yes		
Location:	Engine		
2.4 IGNITION			
Type:	Coil on Plug		
Make:	Porsche		
2.5 FUEL FEED			
Fuel injection System	Model: MS6.6 NG	No:	9F1906023
Make:	Porsche	Type:	Bosch
Injector:	Porsche	No:	9GT128615A

SECTION 3 - TRANSMISSION

3.1 CLUTCH		
Make:	Porsche	
Type:	Diaphragm	
No. of Plates:	3 Friction, 3 Pressure:	Assembly: 9F1141015
Actuation:	Hydraulic	
3.2 TRANSMISSION		
Type:	Electric Sequential	Rear Wheel drive
Make:	Porsche	
Model:	GFJ70	
No. forward speeds:	6	
1 – 13/41 3.154	2 – 17/40 2.353	3 – 20/37 1.850
4 – 24/36 1.500	5 – 24/30 1.250	6 – 38/30 1.071
3.3 FINAL DRIVE		
Diff. Make: Porsche	Ramp Angle = 52° Drive & 35° Coast	
Wheel drive method:	Hypoid crown wheel and pinion	
Ratios:	16/39 2.4375	
Comments:	Oil cooler and pump fitted as standard	
3.4 TRANSMISSION SHAFTS (EXPOSED)		
Description:	CV type Shafts	
Part No:	9F1501201B	
3.5 WHEELS AND TYRES		
Wheel type:	Porsche	Material: Aluminium
Fixture method:	Centre Lock	
	Front	Rear
Wheel Rim	Part No. 9F1601020A	Part No. 9F1601076A
	12J x 18 ET 23.5 mm	13J x 18 ET 44.5 mm

SECTION 4 - GENERAL

4.1 FUEL SYSTEM		
Tank Location:	Front	Capacity: 100 litres
Fuel pump, type and location:	Electric internal	Make: Porsche
4.2 ELECTRICAL SYSTEM		
Voltage:	12 volts negative ground	
Alternator fitted:	Part No. 0PB903018	
Battery Location:	Passenger foot well Part No. 9Y0915107HY	
4.3 BODYWORK		
Type:	Coupe	Material: Smart Aluminium – steel Composite
4.4 DIMENSIONS		
Wheelbase:	2,468 mm +/- 15.0mm	
Overall length	4,585 mm +/- 15.0 mm	
Width Front (bodywork)	1,920 mm +/- 15.0 mm	
Front overhang	1,036 mm +/- 15.0 mm	
Rear overhang (excluding wing)	1,081 mm +/- 15.0 mm	
4.5 PERMITTED MODIFICATIONS		
No modifications or deviations from the standard specification of the <i>Automobile</i> are permitted.		

ATTACHMENT F
Request for Repairs

Engine and Gearbox units must be returned to Porsche Cars Australia for repair.

Attention: Technical Manager
Porsche Carrera Cup Australia

Team Name	
Contact Name	
Contact Phone Number	
Return Fax Number	
Competition Number	
Chassis Number	WP0ZZZ99Z
Date	

Reason for repairs (Include component)

<p>Office Use Only</p> <p>Date Received: _____</p> <p>Approval Nr: _____</p> <p>Approval Date: _____</p>

When completed please email to motorsport@porsche.com.au

ATTACHMENT G

Ride Height Measuring Points

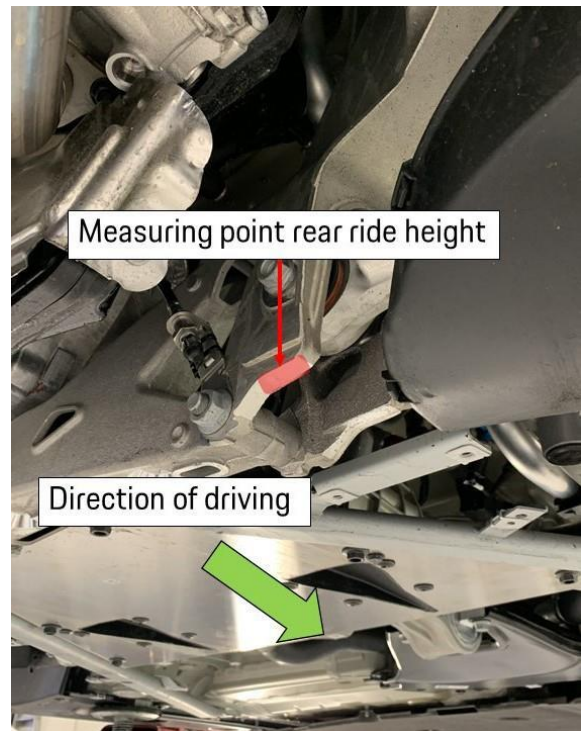
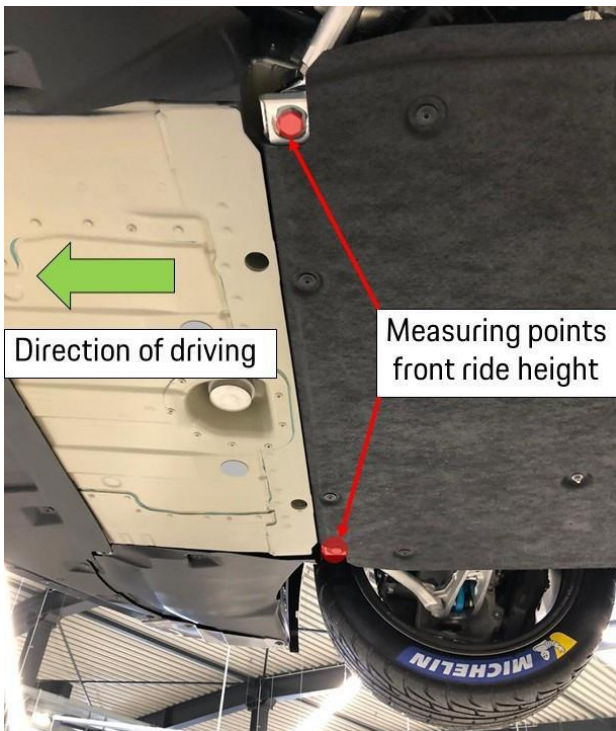
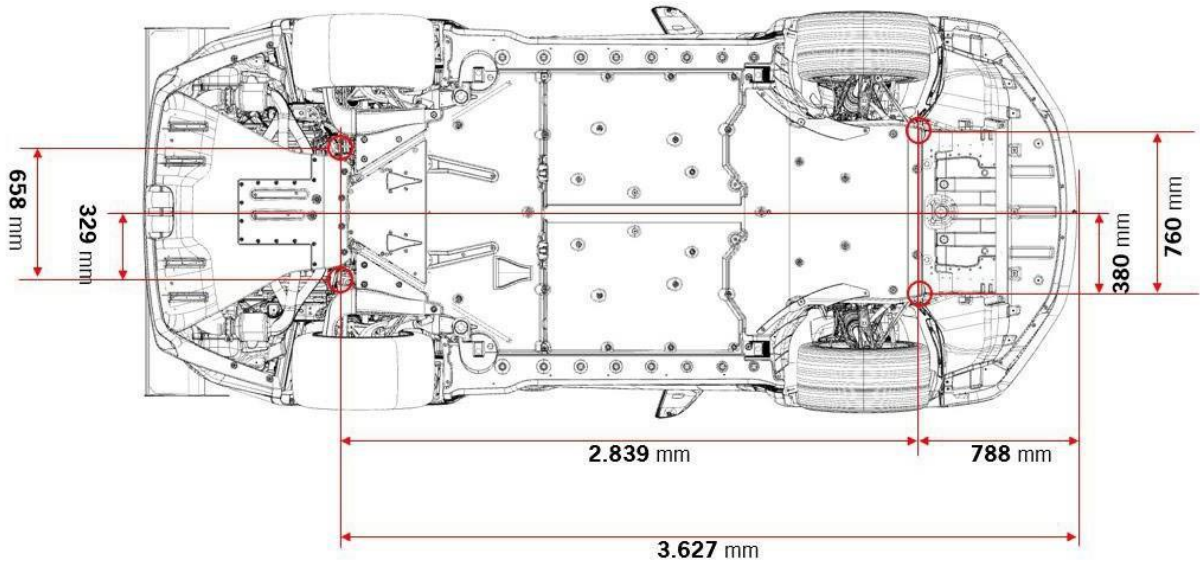

ATTACHMENT H

Exhaust System

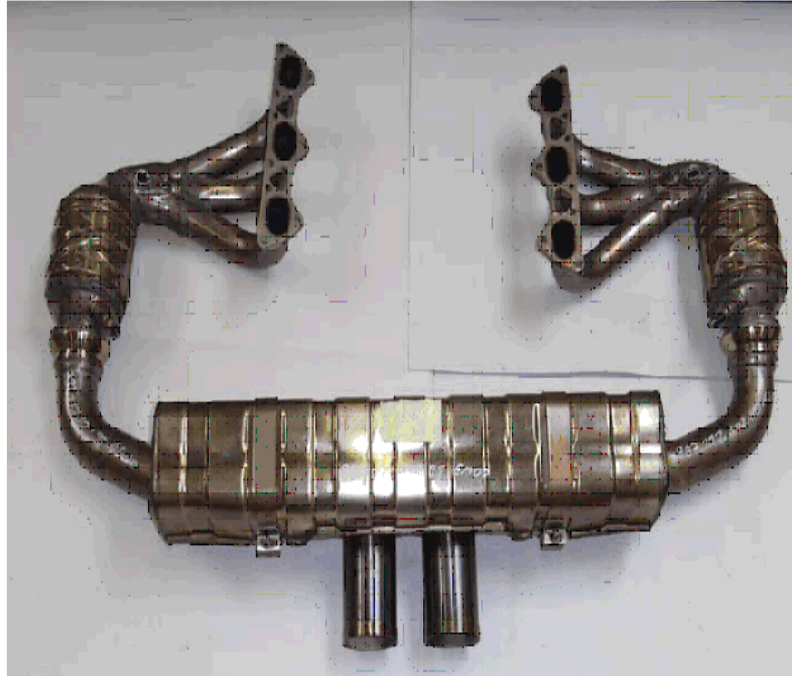

Exhaust System Nr 1 'Supercup' system

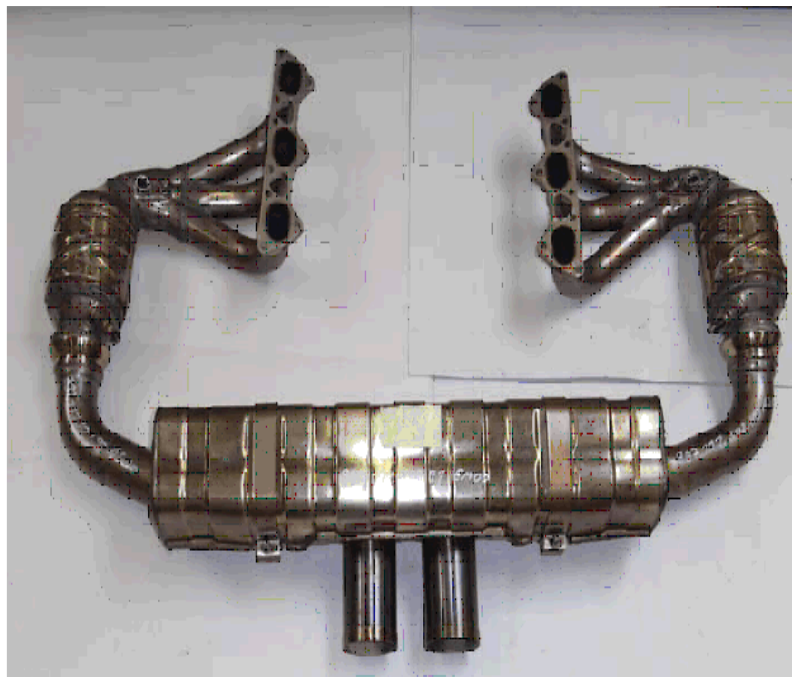

Exhaust System Nr 2 with centre rear muffler and attachments

ATTACHMENT I

Ballast Mounting Points Position

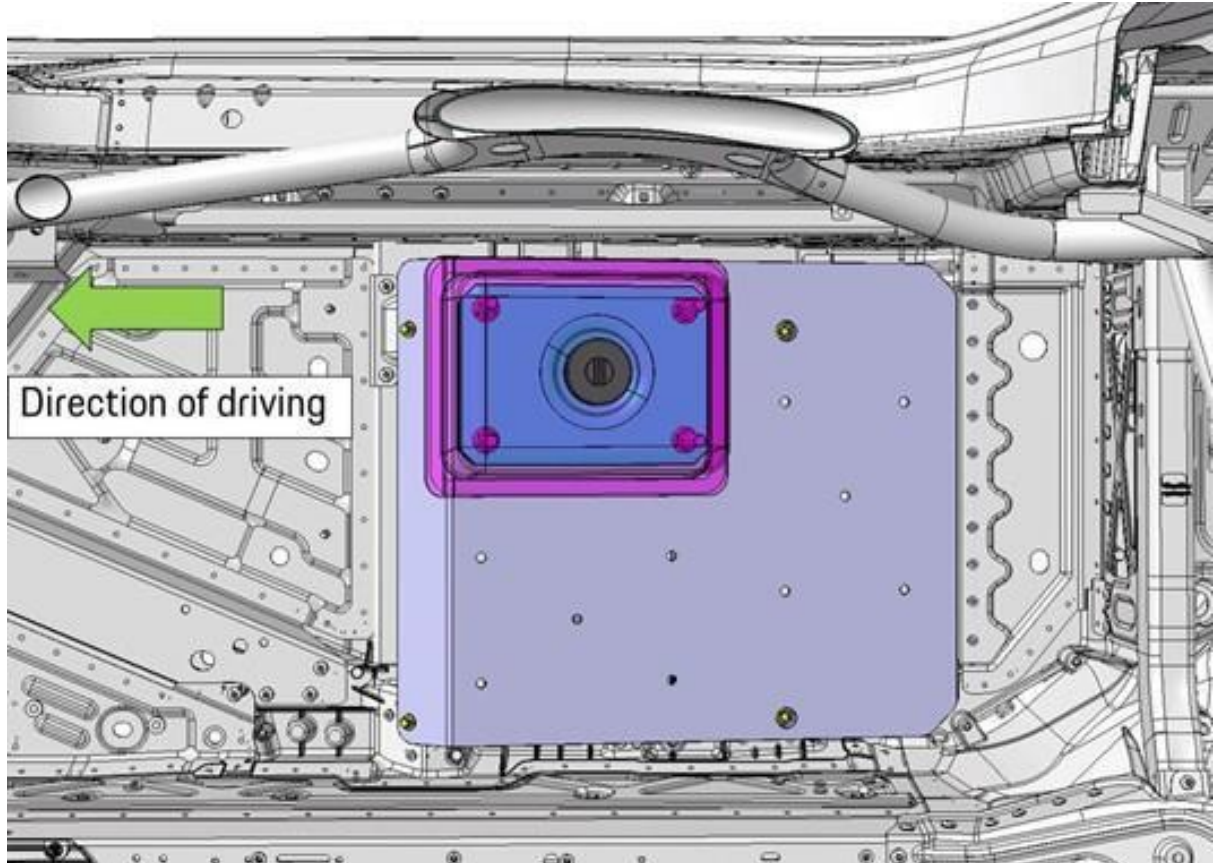

ATTACHMENT J

Transmission/Differential Ramp Angles

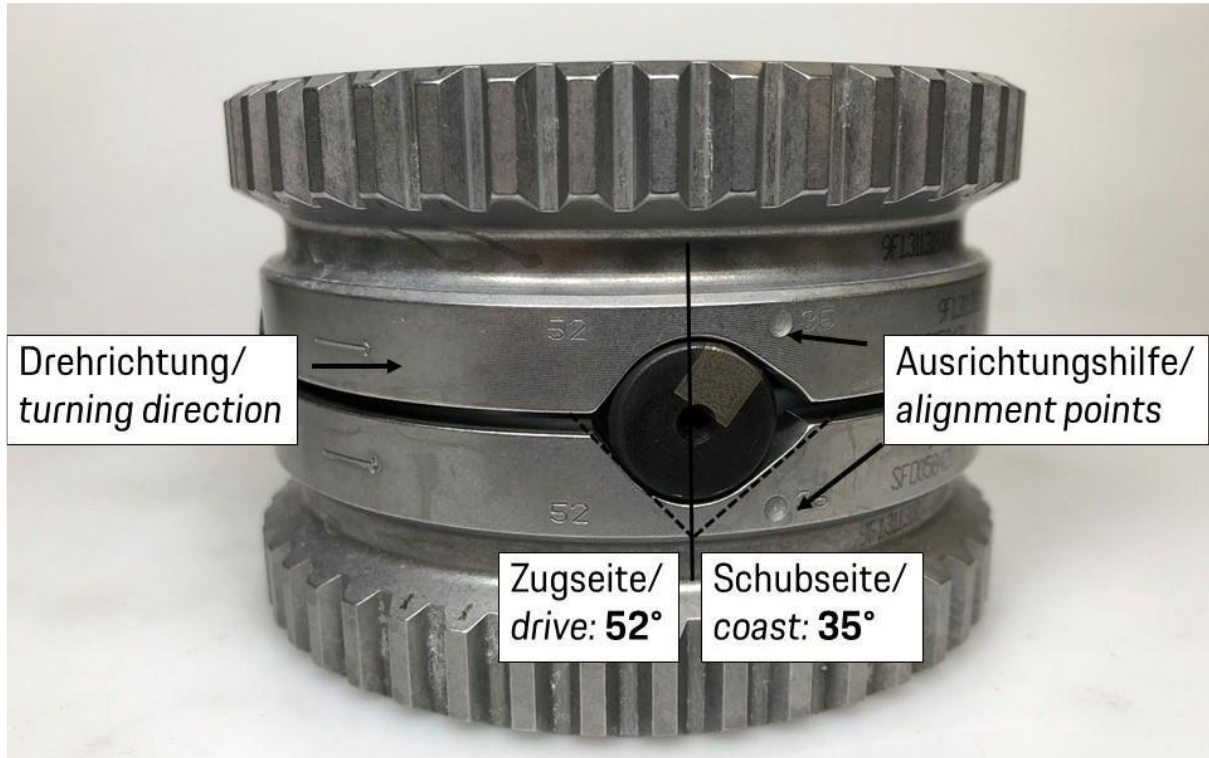

ATTACHMENT K

Seat Padding

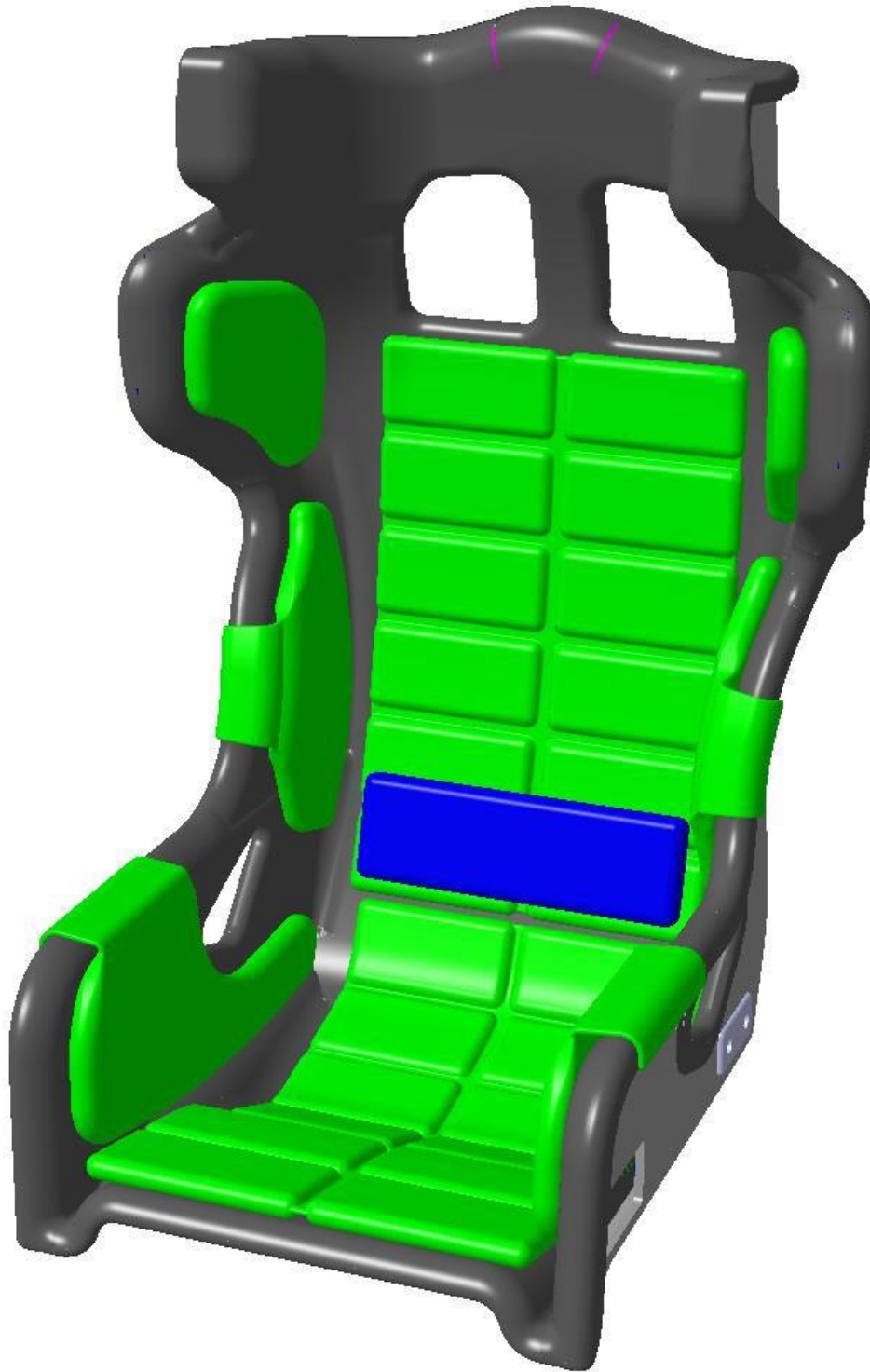

ATTACHMENT L

Alternative Part Number Reference Table

Part	Number	Alternative Number (previous model)
AUXILIARY WEIGHT 2KG/6MM	9F1801141	99150484800
AUXILIARY WEIGHT 3,5KG/10MM	9F1801141A	99150484801
AUXILIARY WEIGHT 6,8KG/20MM	9F1801141B	99150484802
COVERING AUXILIARY WEIGHT	9F1801575	9915048659B
KNURLED NUT COVERING	WHS001903	9915048529B
WHEEL NUT LEFT	9F1412157	9973313079A
WHEEL NUT RIGHT	9F1412158	9973313089A

ATTACHMENT M

Definitions

Championship: 2023 Porsche Paynter Dixon Carrera Cup Australia Championship.

CA: Category Administrator for the *Championship* appointed by the *CM*.

CM: Category Manager for the *Championship* appointed by *Motorsport Australia*.

CRSR: Circuit Racing Standing Regulations published by *Motorsport Australia*.

DRD: Deputy Race Director for the *Championship* appointed by *Motorsport Australia*.

DSA: Driving Standards Advisor for the *Championship* appointed by *Motorsport Australia*.

PCA: Porsche Cars Australia Pty Ltd.

RD: Race Director for the *Championship* appointed by *Motorsport Australia*.

RMC: Race Management Channel.

Round: A round of the *Championship*.

TA: Technical Advisor for the *Championship* appointed by the *CM*.

TD: Technical Delegate for the *Championship* appointed by *Motorsport Australia*.